

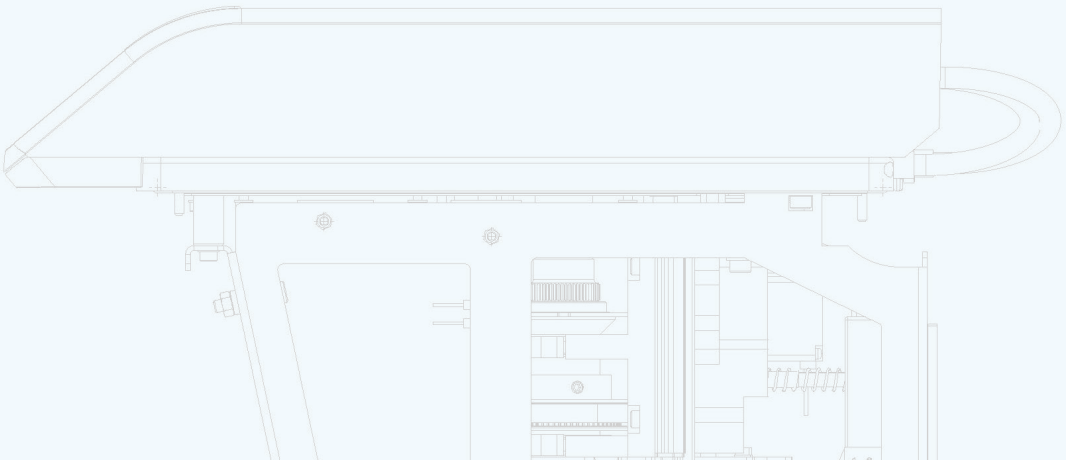

Geri

User Manual

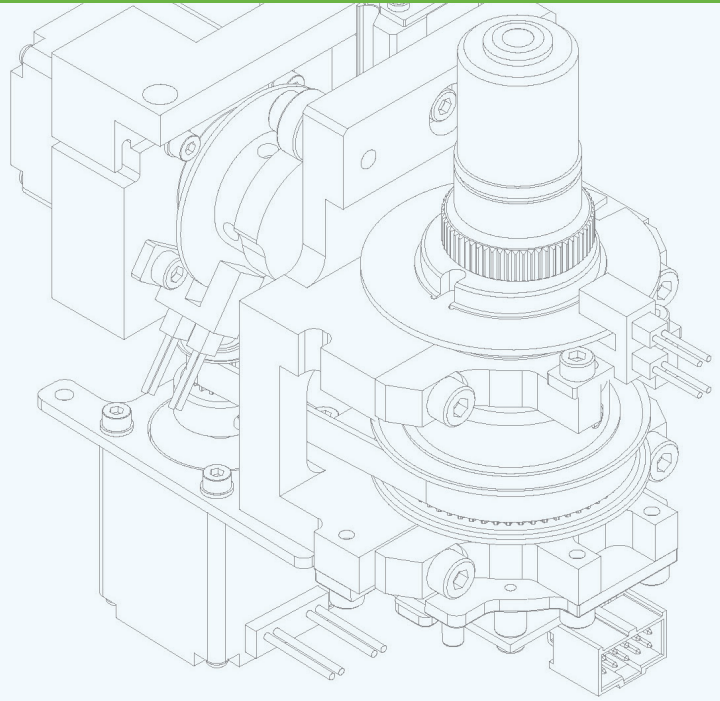

GENERAL INFORMATION

Copyright

This user manual and all contents contained herein are subject to copyright. All rights reserved. No part of this user manual may be reproduced, copied, translated or transmitted in any form or by any means without the prior written approval of Genea Biomedx.

Technical Support

Manufactured in Australia for Genea Biomedx

Genea Biomedx Pty Ltd

Level 2, 321 Kent Street

Sydney, New South Wales, 2000, Australia

Email: info@geneabiomedx.com

Web: www.geneabiomedx.com

QUICK VIEW

Warnings & Cautions	VI
Safety Instructions	1
About Geri	3
Installation & Setup Checklist	35
Operating Geri	44
Alarms & Warnings	71
Index	86
Notes	90

TABLE OF CONTENTS

INTRODUCTION	VII
Warnings & Cautions.....	VII
1. SAFETY INSTRUCTIONS	1
1.1. Hazardous Material.....	1
1.2. Electrical Safety.....	1
1.3. Electromagnetic Compatibility.....	2
1.4. Risk of Explosion.....	2
1.5. Consumables & Accessories.....	2
1.6. Installation & Maintenance.....	2
2. ABOUT GERI	3
2.1. Indications for Use/Intended Use.....	3
2.2. Instrument Description.....	3
2.3. Front of the Instrument.....	5
2.4. Rear of the Instrument.....	6
2.5. Sides of the Instrument.....	8
2.6. Inside Each Chamber.....	9
2.7. Geri Connect & Geri Assess.....	9
3. INSTALLATION & SET-UP	10
3.1. Included Items.....	10
3.2. Additional Items Required.....	10
3.3. Instrument Handling & Placement.....	10
3.4. Gas Supply.....	11
3.4.1. Gas Mixture Required.....	11
3.4.2. Gas Cylinder Regulator Recommendations.....	11
3.4.3. Connection to Gas Cylinder.....	12
3.4.4. Connecting the Gas Supply to Multiple Geri Instruments.....	13
3.4.5. Other Gas Connections.....	14
3.4.6. Gas Filter.....	14
3.4.7. Use of External Charcoal Filters.....	14
3.4.8. External Alarm Connection.....	15
4. BASIC SOFTWARE SETTINGS	16
4.1. Powering On.....	16
4.2. Basic Incubator Settings.....	17

4.3. Incubator Parameters (Graphic Format)	18
4.4. Incubator Parameters	18
4.4.1. Temperature Set-Point	19
4.4.2. CO ₂ Range Set-Point	20
4.4.3. Humidity Alarm On/Off Switch	21
4.4.4. Chamber On/Off Switch	22
4.5. Z-Stack Settings (Focal Plane)	23
4.6. Cycle Type Parameters	24
4.7. Instrument Settings	25
4.7.1. Date & Time	26
4.8. Incubator Information (Including Instrument Name)	26
4.9. Language Localization	27
4.10. CO ₂ Reference Point & Calibration	29
4.10.1. Calibrating the CO ₂ Reference Point	29
4.10.2. Switching the Chamber Environment from Dry to Humid	30
4.10.3. Switching the Chamber Environment from Humid to Dry	31
4.10.4. Maintenance of the CO ₂ Reference Point	31
4.11. Basic Image Settings	32
4.11.1. Camera Focus	33
4.11.2. Image Contrast	33
4.11.3. Camera Alignment	34
4.12. Installation & Set-up Checklist	35
5. ABOUT THE CONSUMABLES	36
5.1. Geri Dish	37
5.1.1. Indications for Use/Intended Use	38
5.1.2. Quality Control	38
5.1.3. Consumable Provided	39
5.1.4. Storage	39
5.1.5. Geri Dish Preparation & Directions for Use	39
5.2. Geri Water Bottle	40
5.2.1. Indications for Use/Intended Use	40
5.2.2. Consumable Provided	40
5.2.3. Storage	41
5.2.4. Geri Water Bottle Preparation & Directions for Use	41
6. ABOUT THE ACCESSORIES	43

6.1. Filter	43
6.1.1. Indications for Use/Intended Use	43
6.1.2. Accessory Provided	43
6.1.3. Storage	43
6.1.4. Filter Preparation & Directions for Use	43
7. OPERATING GERI	44
7.1. Preparing Geri for Use	44
7.2. Homescreen	45
7.3. Chamber Lid Screen	47
7.4. Adding & Editing Patient Details	48
7.4.1. Adding New Patient Details	48
7.4.2. Editing Patient Details	49
7.4.3. Adding a Geri Assess 2.0 Enabled Patient on Geri Connect	49
7.4.4. Allocating a Patient to a Chamber	50
7.5. Accessing a Chamber	51
7.5.1. Placing & Removing a Geri Dish	52
7.5.2. Placing & Removing a Geri Water Bottle	53
7.5.3. Chamber Purge	54
7.6. Chamber Screen	54
7.7. Recording Embryo Development Time-Lapse Images	56
7.7.1. Assign Cycle Type & Determine Estimate of Insemination Time	56
7.7.2. Start Recording & Empty Well Detection	57
7.7.3. Stop Recording	59
7.8. Micro-Well Screen	60
7.9. Reviewing Active Patient Embryos	62
7.9.1. Time-Lapse Playback	62
7.9.2. Image Zoom	62
7.9.3. Z-Stack (Focal Planes)	63
7.9.4. Moving Between Micro-Wells	63
7.9.5. Check Storage Capacity	64
7.10. Tagging Embryos	64
7.10.1. Tagging an Embryo from the Micro-Well Screen	64
7.10.2. Tagging Embryos from the Chamber Screen	65
7.11. Reviewing & Exporting Data	65
7.11.1. Exporting Patient Reports from the Chamber Screen	65

7.11.2. Exporting Time-Lapse Videos from the Micro-Well Screen	66
7.11.3. Reviewing Embryos from Historical Patients	66
7.11.4. Exporting Time-Lapse Videos from Historical Patients	67
7.11.5. Deleting Historical Patients	67
7.11.6. Reviewing Incubator Parameters	68
7.11.7. Exporting Incubator Parameters & Alarm History	68
7.11.8. Exporting Diagnostics Package	69
7.12. Ejecting the External USB Drive	69
7.13. Powering Off	69
7.14. Moving Geri to a Different Physical Location	70
7.14.1. Optics Transport Lock	70
8. ALARMS & WARNINGS	71
8.1. Alarms & Warnings Screen	72
8.2. Alarms & Warnings History Screen	73
8.3. Types of Alarms	74
8.3.1. Temperature Alarm	74
8.3.2. Thermal Cut-Off Alarm	75
8.3.3. Gas Alarm	75
8.3.4. Humidity Alarm	76
8.3.5. Lid Open Alarm	77
8.3.6. Camera Illumination Alarm	77
8.3.7. Service Alarm	77
8.3.8. Loss of Power Alarm	78
8.4. Types of Warnings	78
8.4.1. Image Capture Offline Warning	78
8.4.2. Incubation Controller Offline Warning	78
8.4.3. Other Warning Messages	79
9. SERVICE & MAINTENANCE	80
9.1. Changing the Filter	80
9.2. Changing the Geri Water Bottle	80
9.3. Routine Cleaning	80
9.3.1. Cleaning of the Geri Incubator	80
9.3.2. Disinfection of the Geri Incubator	81
9.4. Annual Maintenance	81
9.5. Decontamination	81





9.6. Backing Up and Removing Data.....	81
10. TECHNICAL SPECIFICATIONS.....	82
10.1. Instrument Specifications.....	82
10.2. Consumable Specifications.....	83
10.2.1. Geri Dish Specifications.....	83
10.2.2. Geri Water Bottle Specifications.....	83
10.3. Accessory Specifications.....	83
10.3.1. Filter Specifications.....	83
10.4. Chamber Sensor Specifications.....	83
10.5. Life of the Instrument.....	85
11. INDEX.....	86
12. NOTES.....	90

INTRODUCTION





It is the owner's responsibility to ensure that all users of Geri have read and understood this user manual before operating the instrument. This user manual is for readers who are familiar with clinical and laboratory techniques, instruments and personal safety procedures and equipment. Before operating Geri please ensure that you have the proper clinical and laboratory training.

Warnings & Cautions

The following warnings and cautions appear in the user manual. It is the owner's responsibility to ensure that all users of Geri have read and understood these warnings and cautions before operating the instrument.

	<p>WARNING:</p> <p>It is the owner's responsibility to ensure that all users of Geri:</p> <ul style="list-style-type: none"> ▪ are trained in all laboratory safety procedures, including the handling of hazardous materials ▪ have read and understood the instructions and warnings contained in this user manual ▪ have received adequate training in the correct operation of the instrument.
	<p>WARNING:</p> <p>Geri contains no user serviceable parts. All repairs must be carried out only by a Genea Biomedx representative or authorized local service representative.</p>
	<p>WARNING:</p> <ul style="list-style-type: none"> ▪ Always ensure that proper laboratory procedures are followed in the handling and disposal of hazardous materials. ▪ All blood products should be treated as potentially infectious.
	<p>WARNING:</p> <p>To reduce the risk of electric shock:</p> <ul style="list-style-type: none"> ▪ do not attempt to repair or modify any part of the instrument ▪ do not remove any of the outer instrument panels or covers ▪ do not place the instrument where it will be exposed to excessive moisture ▪ the instrument must be connected to an earthed power outlet using only the supplied power cord ▪ do not replace the supplied detachable mains supply power cord with an inadequately rated cord ▪ connect the instrument only to an electrical power source with the proper voltage and frequency ▪ disconnect the instrument from the power outlet before cleaning or power cord replacement ▪ immediately replace the power cord if it becomes damaged, frayed, cracked or broken ▪ it is recommended that Geri be connected to an uninterruptible power supply during operation.

	<p>WARNING:</p> <p>To reduce the risk of explosion:</p> <ul style="list-style-type: none"> do not use Geri in an area where flammable gases are present use only the supplied braided PTFE-lined gas connecting hose to connect Geri to the gas supply. The use of any other tubing type may cause incorrect gas concentrations inside the instrument.
	<p>WARNING:</p> <p>For your safety, use only original Genea Biomedx Geri consumables and accessories.</p>
	<p>WARNING:</p> <p>If the instrument has been switched off for an extended period of time, a recalibration of the CO₂ sensors will be required. See “CO₂ Reference Point & Calibration” on page 29.</p>
	<p>WARNING:</p> <ul style="list-style-type: none"> Using a pump-aspirated CO₂ sensor may not yield an accurate result as it may remove all the gas in the chamber if the pump’s aspiration rate is greater than the Geri gas flowrate. High humidity may damage independent CO₂ sensors. Always follow the sensor manufacturer’s instructions for measuring the CO₂ level in the humidity.
	<p>CAUTION:</p> <p>To avoid damage to the instrument, do not attach any cables to the network connection unless directed by an authorized service technician.</p>
	<p>CAUTION:</p> <p>It is the owner’s responsibility to ensure that any embryo culture dishes used within Geri have been validated for use in their facility.</p>
	<p>WARNING:</p> <p>To minimize the risk of injury:</p> <ul style="list-style-type: none"> do not attempt to carry Geri alone; Geri weighs 40.35 kg Geri should only be carried by two people using the appropriate good-lifting and safe-carrying procedures.
	<p>CAUTION:</p> <p>It is recommended that an automatic gas cylinder switchover system be used to ensure the continuity of the gas supply.</p>
	<p>CAUTION:</p> <p>To confirm a new temperature set-point, the multi-function button at the rear of the chamber must be pressed and held within ten seconds of applying any changes.</p>
	<p>CAUTION:</p> <p>To confirm a new CO₂ range set-point, the multi-function button at the rear of the chamber must be pressed and held within ten seconds of applying any changes.</p>

	<p>CAUTION:</p> <ul style="list-style-type: none"> ▪ Humidity impacts on the performance of the Geri chamber CO₂ sensor. ▪ Each time the incubator environment is changed from dry to humid or vice versa, the CO₂ sensor must be re-calibrated (see “CO₂ Reference Point & Calibration” on page 29). ▪ To confirm that the humidity alarm has been switched on or off, the multi-function button at the rear of the chamber must be pressed and held within ten seconds of applying any changes.
	<p>CAUTION:</p> <p>To confirm that a chamber has been switched on or off, the multi-function button at the rear of the chamber must be pressed and held within ten seconds of applying any changes.</p>
	<p>CAUTION:</p> <p>A change in the user interface language may cause an active recording session to skip an image during the Geri application restart.</p>
	<p>WARNING:</p> <ul style="list-style-type: none"> ▪ Ensure the chamber is empty (no embryos) before calibrating the CO₂ reference point. ▪ Setting the CO₂ reference point should not be performed, while the chamber is purging as this will result in an incorrect sensor calibration and a false alarm will be triggered. ▪ The set reference point is in %CO₂, if using an independent sensor reading in ppm it must be converted to %CO₂. ▪ To confirm that a chamber CO₂ reference point setting has been performed the multi-function button at the rear of the chamber must be pressed and held within ten seconds of applying any changes. ▪ When switching the instrument or chamber/s off, it is important to remove the Geri water bottle/s and allow the chamber/s to finish purging. Failure to do so may cause condensation in the chamber which can damage the CO₂ sensor. ▪ Continually changing the incubator environment between dry and humid is not recommended.
	<p>CAUTION:</p> <p>It is the owner’s responsibility to ensure that the Geri system, including all required consumables and accessories, has been validated for use in their facility before the first clinical use and after system maintenance.</p>









**WARNING:**

When using Geri dish:

- It is the owner's responsibility to ensure that any embryo culture dishes used in Geri have been validated for use in their facility.
- The use of deep, steep-walled wells may increase the risk for pipetting damage to embryos during loading and unloading procedures.
- Follow laboratory standard operating procedures for preparing, using and disposing of embryo culture dishes.
- Do not use if the Geri dish pouch is opened, damaged or compromised in any way.
- Always adhere to aseptic technique.
- Inspect the Geri dish for debris or contamination before use and discard the Geri dish if contaminated.
- The Geri dish is single use only. The safety and performance of the Geri dish cannot be assured if it is re-used, re-processed or re-sterilized.
- Do not use the Geri dish if it has passed the expiration date indicated on the label.
- Avoid contacting the Geri dish surface with pipettes or other laboratory equipment.
- Bubbles may form during the Geri dish preparation. If possible, carefully remove any bubbles. If any bubbles remain in the micro-wells, discard the Geri dish.
- Do not touch or contaminate the base of the dish surface directly under the micro-wells.
- Place only one embryo in each micro-well.
- Do not place embryos from more than one patient in the same Geri dish.
- Place the patient identification information on the Geri dish handle using xylene-free permanent markers or labels.
- Do not drop or knock the Geri dish, take care while holding the Geri dish to avoid any sudden movements that may dislodge the embryos from the micro-wells.

**WARNING:**















- Do not use if the Geri water bottle pouch is opened, damaged or compromised in any way.
- Do not fill the Geri water bottle above the maximum fill level.
- Always adhere to aseptic technique.
- Inspect the Geri water bottle for debris or contamination before use and discard if contaminated.
- Do not use the Geri water bottle if it has passed the expiration date shown on the label.
- The Geri water bottle is single use only. The safety and performance of the Geri water bottle cannot be assured if it is re-used, re-processed or re-sterilized.
- The expected time for a full Geri water bottle (from the maximum fill level) to reach the minimum fill level is two (2) weeks.
- It is recommended to use warmed or room temperature sterile water to fill the water bottle.
- Do not drop or knock the Geri water bottle.
- Ensure that no water has been spilled or splashed on the outside of the Geri water bottle or in the Geri chamber as this can cause condensation that will impact the quality of images taken by Geri.
- It is recommended that oil is used to culture even in a humidified chamber as the humidity will not eliminate the evaporation of media, it will only reduce the evaporation rate.

	<ul style="list-style-type: none"> When switching the instrument or chamber/s off, it is important to remove the Geri water bottle/s and allow the chamber/s to finish purging. Failure to do so may cause condensation in the chamber which can damage the CO₂ sensor.
	<p>CAUTION:</p> <p>Do not re-use the filter. The performance of the filter in improving the purity of the gas may be compromised.</p>
	<p>WARNING:</p> <p>To minimize the risk of embryo displacement, always take care when closing the chamber lid and avoid bumping or knocking Geri.</p>
	<p>WARNING:</p> <p>If a chamber is found with the chamber lid latch not fully engaged, the lid should be opened and closed before being re-latched. Opening and closing the lid initiates a purge cycle to ensure the optimal CO₂ environment is re-established as quickly as possible.</p>
	<p>WARNING:</p> <ul style="list-style-type: none"> Ensure Geri water bottles are removed from each chamber before switching the Geri instrument off. The Geri chamber CO₂ reference point should be reset whenever the chamber operating environment changes from dry to humid, or vice versa. When changing from a dry to a humid environment, allow the sensor to stabilize uninterrupted in the humid chamber for at least three (3) days before setting the reference point (see “CO₂ Reference Point & Calibration” on page 29).
	<p>CAUTION:</p> <p>Do not tap the Stop Recording icon when temporarily removing a Geri dish for media change. Do not tap the Stop Recording icon until the patient’s recording session is complete.</p>
	<p>WARNING:</p> <p>During embryo development, time-critical checkpoints should be reviewed in real time to allow for alternative assessment under microscopy if the assessment using the recorded image is not clear.</p>
	<p>WARNING:</p> <ul style="list-style-type: none"> Never power off the instrument while embryos are being cultured in any of the chambers. When powering off the instrument, remove the Geri water bottles from each chamber and allow the chamber to finish a purge cycle.
	<p>CAUTION:</p> <p>Federal Law (USA) restricts this device to sale by or on the order of a licensed physician or other healthcare practitioner.</p>



* ISO 15223-1 Medical Devices: symbols to be used with medical device labels, labeling and information.

Definition of Symbols

The following symbols are used on the Geri instrument and consumables:

Symbol	Title	*ISO 15223-1 Reference #
	Date of Manufacture	2497
	Batch Code	2492
	Serial Number	2498
	Reference	2493
	Sterilized using irradiation	2502
	Use By	2607
	Keep Away from Sunlight	0624
	Do Not Resterilize	2608
	Single Use Only, Do Not Re-Use	1051
	Caution, Consult the User Manual	1641
	Do Not Use if the Package is Damaged	2606
	This Instrument is Subject to Laws Regarding the Disposal of Electronic Medical Equipment as Outlined in the WEEE Directive (2006/96/EC)	
	Product conforms to the Medical Device Directive 93/42/EEC (BSI)	
	Federal Law (USA) restricts this device to sale by or on the order of a licensed physician or other healthcare practitioner	

1. SAFETY INSTRUCTIONS

	<p>WARNING:</p> <p>It is the owner's responsibility to ensure that all users of Geri:</p> <ul style="list-style-type: none"> ▪ are trained in all laboratory safety procedures, including the handling of hazardous materials ▪ have read and understood the instructions and warnings contained in this user manual ▪ have received adequate training in the correct operation of instrument.
	<p>WARNING:</p> <p>Geri contains no user serviceable parts. All repairs must be carried out only by a Genea Biomedx representative or authorized local service representative.</p>

1.1. Hazardous Material

	<p>WARNING:</p> <ul style="list-style-type: none"> ▪ Always ensure that proper laboratory procedures are followed in the handling and disposal of hazardous materials. ▪ All blood products should be treated as potentially infectious.
---	---

1.2. Electrical Safety

	<p>WARNING:</p> <p>To reduce the risk of electric shock:</p> <ul style="list-style-type: none"> ▪ do not attempt to repair or modify any part of the instrument ▪ do not remove any of the outer instrument panels or covers ▪ do not place the instrument where it will be exposed to excessive moisture ▪ the instrument must be connected to an earthed power outlet using only the supplied power cord ▪ do not replace the supplied detachable mains supply power cord with an inadequately rated cord ▪ connect the instrument only to an electrical power source with the proper voltage and frequency ▪ disconnect the instrument from the power outlet before cleaning or power cord replacement ▪ immediately replace the power cord if it becomes damaged, frayed, cracked or broken ▪ it is recommended that Geri be connected to an uninterruptible power supply during operation.
---	---

1.3. Electromagnetic Compatibility

Geri has been tested to IEC/EN 61010-1 3rd Edition to demonstrate compliance with the electrical safety requirements. Geri has been tested and found to comply with the electromagnetic compatibility (EMC) limits for laboratory equipment as specified by EN 61326-1:2013 (IEC 61326-1:2012 Ed 2). These limits are designed to provide reasonable protection against harmful interference in a typical laboratory environment.

Medical electrical equipment requires special precautions regarding EMC and must be installed and operated according to these instructions. It is possible that high levels of radiated or conducted radio-frequency electromagnetic interference (EMI) from portable and mobile RF communications equipment or other strong or nearby radio-frequency sources could result in performance disruption of Geri. Under these conditions the Geri incubator temperature and gas control will continue to operate correctly. However, the time-lapse recording and playback functionality may be temporarily interrupted and false CO₂ alarms may be raised. The Geri incubator will self-recover when the EMC disturbance is removed.

1.4. Risk of Explosion



WARNING:

To reduce the risk of explosion:

- do not use Geri in an area where flammable gases are present
- use only the supplied braided PTFE-lined gas connecting hose to connect Geri to the gas supply. The use of any other tubing type may cause incorrect gas concentrations inside the instrument.

1.5. Consumables & Accessories



WARNING:

For your safety, use only original Genea Biomedx Geri consumables and accessories.

1.6. Installation & Maintenance

The installation, inspection, calibration and service of Geri must be carried out only by an authorized service technician.

2. ABOUT GERI

2.1. Indications for Use/Intended Use

The Geri Embryo Incubator is intended to provide an environment with controlled temperature and mixed gas (CO₂ and other gases) for the development of embryos. The Geri Embryo Incubator has an integrated camera and optics for imaging and viewing embryos during incubation, for a maximum time of 120 hours.

Geri Connect and Geri Assess are optional software accessories for the Geri Embryo Incubator. Geri Connect is intended for access and review of time-lapse data generated by the Geri Embryo Incubator on a local area network. Geri Assess is intended for viewing and recording embryo development events from images captured using the Geri Embryo Incubator. Geri Assess includes a user annotation function for capturing information on embryo development parameters and a user-defined modeling function that allows the user to combine annotated information on embryo development parameters to aid in embryo selection. Geri Connect and Geri Assess do not control any hardware components in the Geri Embryo Incubator. Geri Connect and Geri Assess are combined in the same software package and must be used together.

The Geri Dish is intended to be used for preparation, storage and imaging of human embryos. The Geri Dish is intended to be used only with the Geri Embryo Incubator.

2.2. Instrument Description

Geri is designed to accurately maintain:

- a user-specified temperature within the range of +35°C to +40°C for each of the instrument's chambers
- a consistent gas flow.

Geri uses pre-mixed gas to maintain an optimal culture environment for gametes and/or embryos within each of the instrument's six incubation chambers. Geri requires a pre-mixed gas blend for correct operation. The recommended gas mixture blend is 6% CO₂, 5% O₂, 89% N₂ (at sea level) or high purity 6% CO₂ in air (recommended tolerances ±0.2%).

Accurately maintaining temperature in a 6% CO₂ low-oxygen (5%) environment is of critical importance in culturing embryos. For this reason, Geri has been designed with specific control and safety systems. Whenever any of the instrument's chamber lids are opened and closed, Geri will perform a gas purge and briefly increase the chamber's temperature. This ensures that the chamber's user-selected gas and temperature set-points are reached as quickly as possible. Geri also has two independent temperature-control systems in each chamber, each with its own heating element. Should one of these temperature-control systems fail, an alarm will sound and the other system will compensate to maintain the chamber's temperature and enable sufficient time for any Geri dishes to be transferred. Similarly, the gas connections for each chamber are designed so that a fault in one chamber will have no impact on any other chamber.

Geri constantly monitors critical parameters within the incubator. Should any parameter

exceed its normal range, an alarm will sound to alert users of the fault. Geri can also be connected to an independent, external alarm that can alert users of any faults that occur outside of normal working hours.

Many laboratories require independent, external validation of incubator temperature and CO₂ levels. Geri has been designed to enable the connection of external monitoring devices for measurements to be taken.

Each of the instrument's chambers is fitted with a high-resolution camera that enables Geri to take time-lapse images of an embryo, every five minutes. Geri automatically selects the most in-focus image from the available z-stack. This best focal plane image is then cropped to the embryo and encoded into a video.

2.3. Front of the Instrument

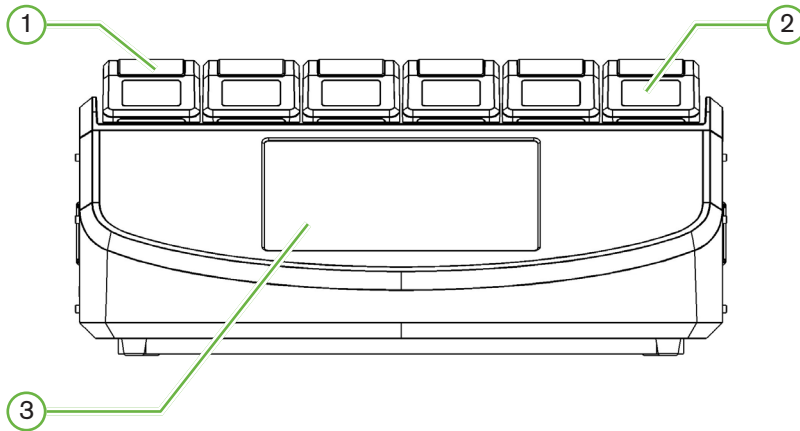

① Chamber Lid and Latch

The chamber lid and latch are designed for easy one-handed operation.

② Chamber Lid Screen

Each chamber lid has a 5.5 cm LCD screen that displays the key information for that chamber.

③ Geri Touchscreen

The main user interface of Geri is a 30.7 cm capacitive touchscreen. All the settings and functions of Geri can be accessed via the touchscreen.

2.4. Rear of the Instrument

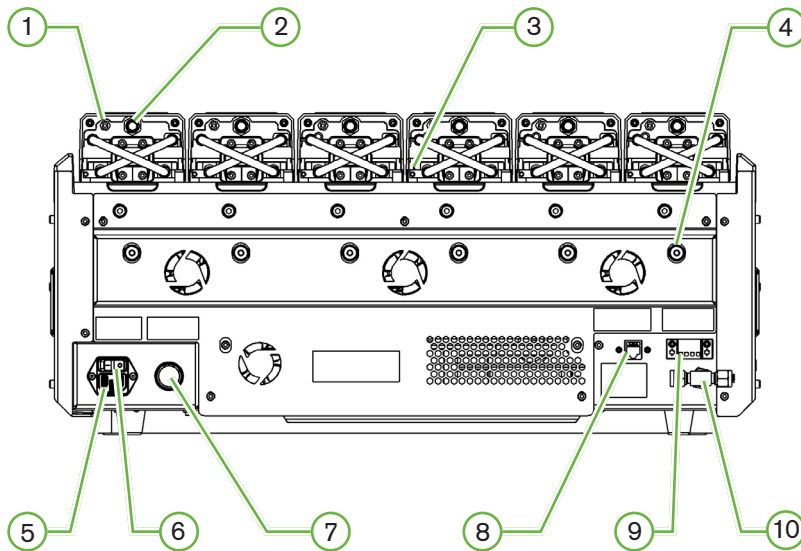

① External Monitoring Port: Gas

If required, CO₂ can be measured using an independent diffusion type CO₂ sensor suitable for use with low gas flow connected to Geri through the gas external monitoring port.

NOTE: It may take up to 15 minutes for the reading to stabilize.

Recommended Sensor: Vaisala CARBOCAP® Carbon Dioxide Probe GMP251 + Calibration adapter for GMP251 + Nafion membrane tubing (for measuring CO₂ in a humid environment).

Please follow Vaisala's instructions for using the Nafion tubing.



WARNING:

- Using a pump-aspirated CO₂ sensor may not yield an accurate result, as it may remove all the gas in the chamber if the pump's aspiration rate is greater than the Geri gas flow rate.
- High humidity may damage independent CO₂ sensors. Always follow the sensor manufacturer's instructions for measuring the CO₂ level in the humidity.

② Multi-Function Button/Alarm Disable

The multi-function button at the rear of each chamber is used to:

- temporarily disable an audible alarm
- temporarily display on the chamber lid screen the humidity alarm enabled indicator and the chamber set-points for temperature and CO₂
- confirm any changes made to set-points on the settings screens.

③ External Monitoring Port: Temperature

If required, an external temperature-measurement probe can be connected to this port.

④ Optics Transport Lock

Before moving Geri, engage the optics transport lock to minimize movement and avoid damaging the internal optics system (see “7.14. Moving Geri to a Different Physical Location” on page 70).

⑤ Mains Power Socket

Connect the supplied earthed power cord to this point.

⑥ Power Switch

The power switch is used to power Geri on or off.

⑦ Loss of Power Alarm Silence Button

The loss of power alarm silence button is used to silence a loss of power alarm.

⑧ Network Connection

The network connection enables Geri to connect to a network.

**CAUTION:**

To avoid damage to the instrument, do not attach any cables to the network connection unless directed by an authorized service technician.

⑨ External Alarm Connection

If required, an external alarm can be connected to this point. Ensure that any powered alarm connected to the external alarm connection does not exceed the stated contact rating (see “10. Technical Specifications” on page 82).

⑩ Gas Connection

Connect the gas supply to this point (see “3.4. Gas Supply” on page 11).

2.5. Sides of the Instrument

Geru, Left-Hand Side

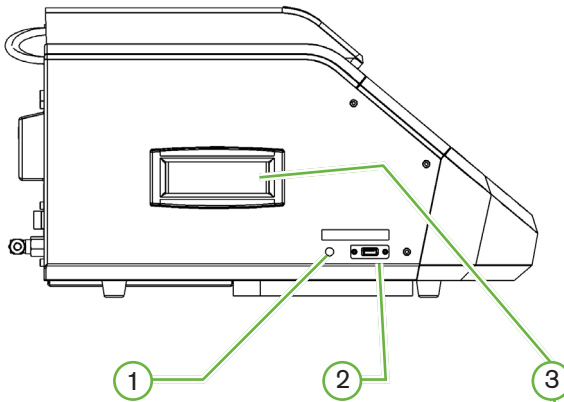

Geru, Right-Hand Side

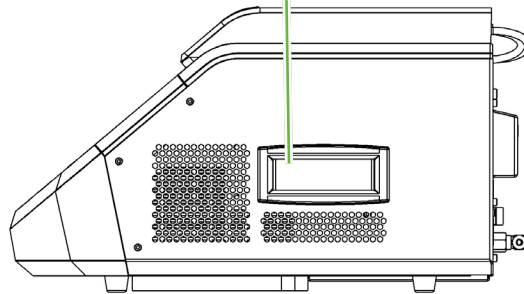

① PC Power Button

The PC power button is used to manually power off and power on the PC that controls the software and touchscreen if it becomes unresponsive.

② USB Port

The powered USB 3.0 port is used to:

- upgrade software
- export Geru data.

③ Carrying Handles

Always use the carrying handles when moving Geru to minimize the risk of personal injury.

2.6. Inside Each Chamber

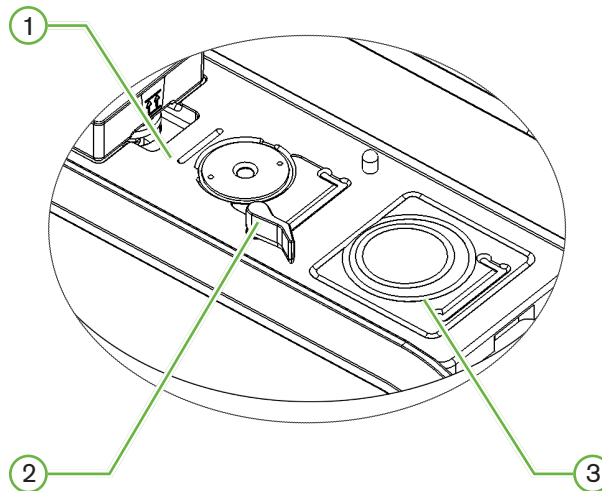

① Gas Filter and Geri Water Bottle Position

The gas filter and water bottle are connected to this point.

② Camera Position

Each chamber has a dedicated camera to take images of the embryo.

③ Front Dish Position (Non-Camera)

The front dish position accepts NUNC™ 4-well dishes, and FALCON® and NUNC™ 35 mm and 60 mm round dishes.

NOTE: Both the front dish position and the camera position can hold a dish at the same time. The front dish position can contain a dish with embryos or a dish with media and oil that needs to be equilibrated prior to embryos being placed in the dish. The user can also place a dish in the front dish position containing phenol red for testing or monitoring pH levels.



CAUTION:

It is the owner's responsibility to ensure that any embryo culture dishes used within Geri have been validated for use in their facility.

2.7. Geri Connect & Geri Assess

The optional Geri Connect & Geri Assess software enables access to and review of time-lapse data on a local area network. The software also improves the viewing and recording of user-defined embryo development events and the observations of embryo images captured by the Geri Incubator.

By default, the best focal plane, embryo-cropped video is displayed for enhanced playback on Geri Connect & Geri Assess. See QFRM1020 Geri Connect & Geri Assess User Manual for further details.

3. INSTALLATION & SET-UP

3.1. Included Items

The following items are supplied:

- 1 x Geri instrument
- 1 x country-specific power cord
- 1 x braided PTFE-lined gas connecting hose and nuts
- 1 x printed Geri user manual

3.2. Additional Items Required

The following items are required for use with Geri:

- a clean gas supply with an automatic gas cylinder switchover system
- an uninterruptible power supply
- an external USB hard drive.

3.3. Instrument Handling & Placement

**WARNING:**

To minimize the risk of injury:

- do not attempt to carry Geri alone; Geri weighs 40.35 kg
- Geri should only be carried by two people using the appropriate good-lifting and safe-carrying procedures.

Geri must be installed only by an authorized service technician. During installation, testing and calibration of the instrument are performed to ensure correct operation.

Installation Requirements:

- A clean, controlled environment is essential for the correct operation of the instrument. When the temperature set-point of Geri is +37°C and above, the recommended ambient temperature range is between +18°C and +30°C. Should the temperature set-point be less than +37°C, then the recommended ambient temperature range is reduced to between +18°C and +28°C.
- Geri must be placed on a sturdy, level surface away from air-conditioning outlets, heaters, excessive moisture or direct sunlight.
- Geri must not be placed in proximity to flammable gases.
- There should be a minimum clearance of 100 mm around each Geri instrument used to enable adequate ventilation.
- Geri should not be placed within 1.5 m of any patient.

3.4. Gas Supply

3.4.1. Gas Mixture Required

The concentration of CO₂ must be controlled to maintain the operating pH range of 7.2–7.4 in bicarbonate buffered culture media. The required concentration of CO₂ in the gas mixture is dependent on the culture media used, the altitude above sea level and the relative humidity within the chamber.

The following graph provides an approximation of the required CO₂ concentration at altitudes above sea level¹:

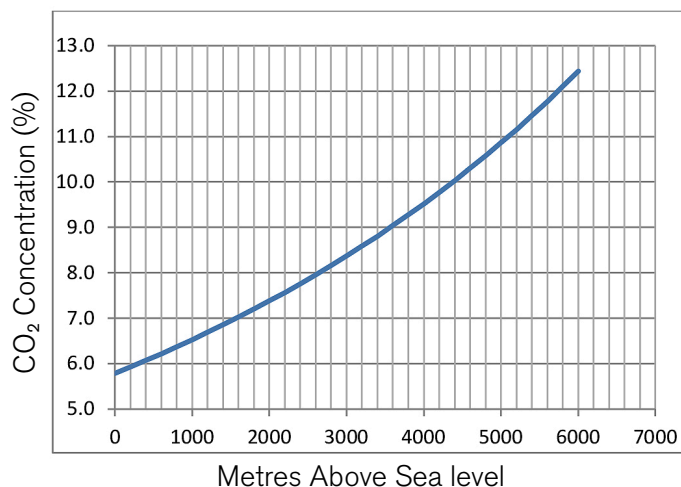

1. D. Mortimer and S.T. Mortimer, 'Essential Feature in Media Development for Spermatozoa, Oocytes, and Embryos', in P. Quinn (ed.), Culture Media, Solutions, and Systems in Human ART, Cambridge, Cambridge University Press, 2014, p. 54.

3.4.2. Gas Cylinder Regulator Recommendations

There must be a reliable gas connection between Geri and the gas-supply cylinder. The gas regulator is an important part of the gas delivery system. It is essential that the gas regulator is designed and manufactured to carry medical-grade gases and to not contaminate the gas stream.

The following are recommended features for the gas cylinder regulator:

- single-stage, high-purity regulator
- metal-to-metal diaphragm seal
- stainless steel diaphragm that will not contaminate high-purity gas streams
- dual scale gauges (optional)
- fully configured for a special-blend medical-grade gas cylinder
- delivery pressure within the range of 135 kPa to 165 kPa at the Geri gas inlet
- a minimum flow capability of 1080 mL/min per Geri instrument is required during the purge cycle
- the outlet fitting of the regulator is to be a Swagelok® SS-400-1-4RT fitting to fit the braided PTFE-lined gas connecting hose supplied with Geri.

Swagelok® Connector

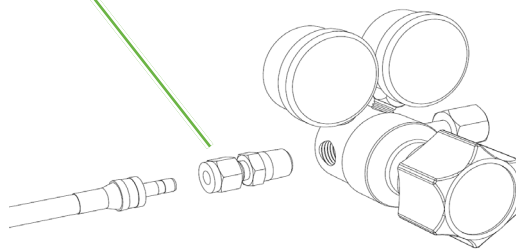

3.4.3. Connection to Gas Cylinder

**CAUTION:**

It is recommended that an automatic gas cylinder switchover system be used to ensure the continuity of the gas supply.

A braided PTFE-lined gas connecting hose is supplied with Geri for connection to the gas cylinder.

The braided PTFE-lined gas connecting hose has a nontoxic, low-permeability PTFE lining that prevents loss of CO₂ in the delivery of the gas mixture. Do not use hoses made of silicone or PVC as part of the gas-delivery system. Silicone and PVC are more permeable materials and their use may result in incorrect gas concentrations reaching Geri.

Geri and the supplied braided PTFE-lined gas connecting hose are fitted with Swagelok® 1/4" series tube fittings. These fittings use a tapered ferrule to provide a leak-free seal on connections. It is also recommended that a pressure regulator with these fittings is used because the ferrules on the braided PTFE-lined gas connecting hose are pre-swaged before shipping and a ferrule and backnut are not required on the cylinder-mounted regulator.

To connect the braided PTFE-lined gas connecting hose to a fitting:

1. Ensure there is no debris in the fitting body, tube end or ferrules.
2. Insert the tube adaptor with pre-swaged ferrules into the fitting body until the front ferrule seats.
3. Hand-tighten the backnut and then use a 9/16" spanner to further slightly tighten the backnut.
4. Repeat the process to ensure the braided PTFE-lined gas connecting hose is connected to both the regulator outlet fitting and to the Geri inlet fitting.
5. Cover the seals with a small amount of soapy water to ensure the seals are gas tight. If there are any bubbles, repeat the above steps and further tighten the backnut.

For any un-used Geri gas connections, ensure the blanking plug is also tightened for a gas-tight seal.

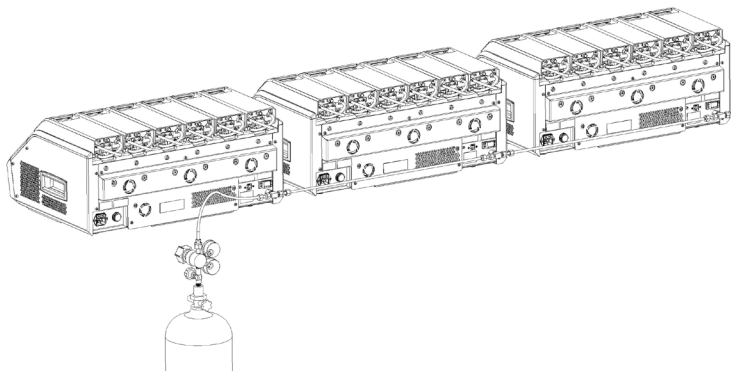
3.4.4. Connecting the Gas Supply to Multiple Geri Instruments**To connect multiple Geri instruments to a single gas supply:**

1. Remove the blanking plugs from the second gas connection of all instruments except for the last instrument in the sequence.
2. Connect the braided PTFE-lined gas connecting hose from the last instrument in the sequence to the previous instrument.

Three Geri instruments can be connected in series to a single gas supply. Contact your authorized service technician for further information.

3.4.5. Other Gas Connections

For other gas connections or gas delivery systems, Genea Biomedx recommends that the user contact their gas equipment supply center for installation advice. For gas connection information, contact the Swagelok® distributor in your country (see www.swagelok.com for further information).

3.4.6. Gas Filter

To improve the purity of the gas entering a chamber and to prevent any damage to the instrument caused by water entering the gas line (such as spills occurring during cleaning or dish placement), a disposable hydrophobic gas filter (GERI-FIL-50) is used. The filter is located at the rear of each chamber.

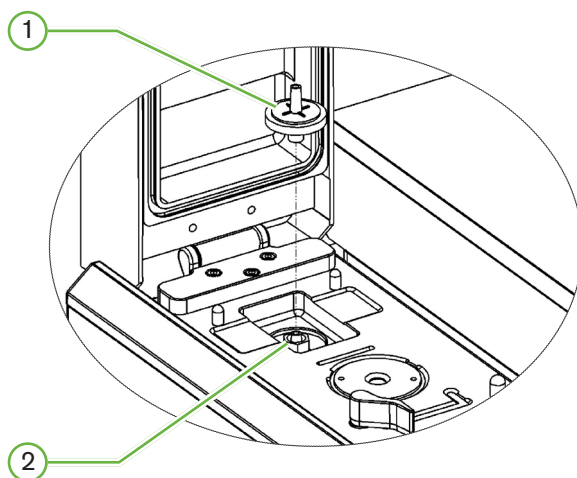

① Gas Filter

② Gas Filter Position (Luer Lock)

To install: twist the filter in a clockwise direction into the Luer lock until secure.

To remove: twist the filter in a counterclockwise direction.

NOTE: Replace the filter every two months.

3.4.7. Use of External Charcoal Filters

If an external charcoal filter is used, the CO₂ reading will drop for approximately 3-5 hours while charcoal filter saturation occurs. Once the filter is saturated the CO₂ reading will return to normal operational levels.

NOTE:

- During charcoal filter saturation the Geri Gas Alarm may be activated indicating the CO₂ level has dropped. Do not reset the CO₂ values during filter saturation.
- Only use gas-line charcoal filters cleared for use in the United States.

3.4.8. External Alarm Connection

Geri includes an external alarm connection that can be used with alarm transmitters activated by means of a contact closure.

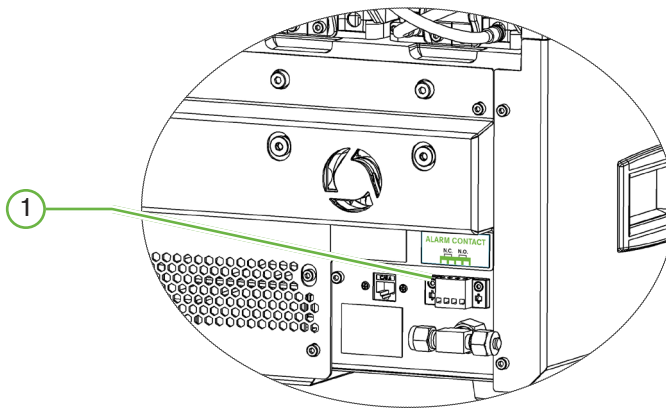

① External Alarm Connection

If required, an external alarm can be connected to this point. Ensure that any powered alarm connected to the external alarm connection does not exceed the stated contact rating (see “10. Technical Specifications” on page 82).

4. BASIC SOFTWARE SETTINGS

4.1. Powering On

The power switch of the Geri Instrument is located at the rear of the instrument, above the mains power socket.

To power on Geri:

1. Connect the supplied power cord to the mains power socket of Geri.
2. Connect the power cord to the mains power supply.
3. Switch the mains power supply on.
4. Switch on the power switch of Geri.

After powering on, Geri automatically completes the following processes:









- The touchscreen is switched on.
- Each chamber screen is switched on.
- Geri performs a self-test and an alarm is sounded if any faults are detected.
- Geri returns each chamber back to its previous chamber set-points. The heating elements and gas-flow rates are automatically increased to reach the set-points.

During the power-on process, the key incubator parameters will be outside the set-point ranges. As a result, alarms for temperature and CO₂ will be displayed on the Geri touchscreen and an audible alarm will sound. The audible alarm can be temporarily disabled by pressing the multi-function button located at the rear of each chamber. If all six chambers are out of range during the power-on process, the multi-function button at the rear of each chamber must be pressed. The audible alarms are automatically re-enabled once the chamber set-points are within range.

4.2. Basic Incubator Settings

The basic incubator and software settings screen is accessed by tapping the settings icon  on the homescreen (see “7.2. Homescreen” on page 45).

To access a specific incubator and software setting, select the appropriate tab as listed below:

Icon	Description
	Incubator Parameters (Graphic Format): Tap this icon to review the incubator parameters.
	Incubator Parameters: Tap this icon to review and edit the chamber on/off, temperature and CO ₂ range set-points and humidification on/off.
	Z-Stack (Focal Plane) Settings: Tap this icon to review and edit focal planes information.
	Cycle Type Parameters: Tap this icon to review and edit cycle types associated with the embryo.
	Adjust Date and Time Parameters.
	Incubator Information: Tap this icon to review software version information and serial number, edit the instrument name and export the diagnostics package for service and support.
	Localization: Tap this icon to edit the incubator’s user interface language.
	CO ₂ Reference Point: Tap this icon to review and set the CO ₂ reference point for each chamber.
	Eject Drive: Tap this icon to eject the external USB drive.
	Incubator Shutdown: Tap this icon to power down the Geri software.
	Export Parameters Function: Tap this icon to export parameter details to the export drive location.



CAUTION:

To avoid damage to the instrument, do not attach any cables to the network connection unless directed by an authorized service technician.

4.3. Incubator Parameters (Graphic Format)

Each chamber's temperature from the previous 24-hour period is displayed on the incubator parameters (graphic format) screen, as well as alarms triggered for CO₂ and lid opens.

From the basic incubator and software settings screen, tap the incubator parameters (graphic format) icon  to access the incubator parameters (graphic format) screen.

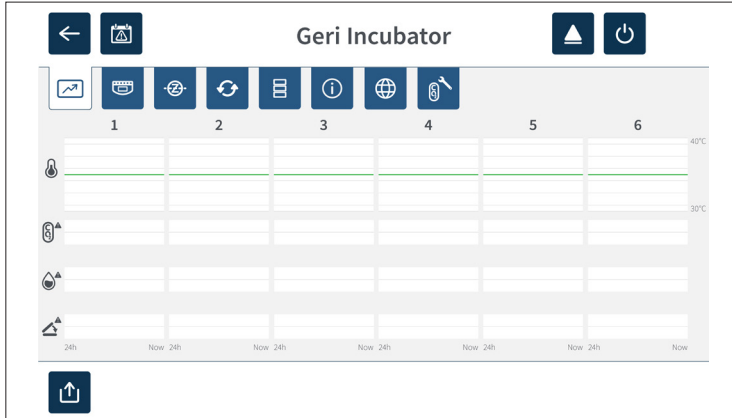

4.4. Incubator Parameters

From the incubator parameters screen, the humidity alarm can be turned on or off. Individual chambers can also be turned on or off.

NOTE: Changes to the temperature set-points and CO₂ range set-points must be made only by a Genea Biomedx representative or authorized local service technician.

The screen also displays the reference point of CO₂ gas concentration from the gas supply attached to Geri. This setting is part of the initial installation process performed by the authorized service technician.

From the basic incubator and software settings screen, tap the incubator parameters icon  to access the incubator parameters screen.

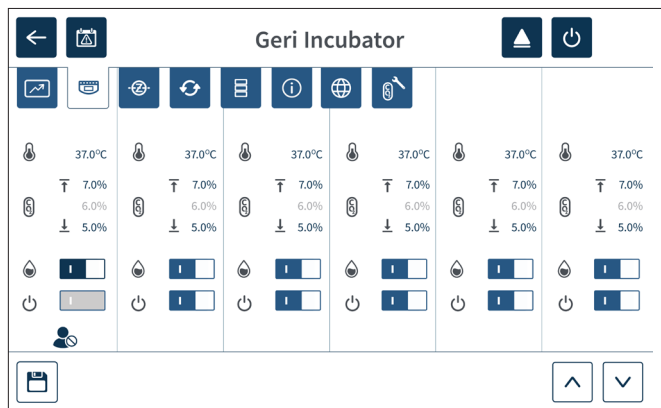

4.4.1. Temperature Set-Point







CAUTION:

To confirm a new temperature set-point, the multi-function button at the rear of the chamber must be pressed and held within ten seconds of applying any changes.

Each chamber has an individually maintained temperature set-point. When Geri detects temperature beyond this range an alarm is triggered (see “8.3.1. Temperature Alarm” on page 74). The default temperature set-point is +37°C.

NOTE: The temperature is displayed in degrees Celsius.

To change the temperature set-point:

1. Locate the appropriate chamber on the incubator parameters screen.
2. Tap the temperature set-point field (located next to the temperature icon ) to select the temperature set-point to be changed.
3. Use the arrow icons   to adjust the temperature set-point as required.
4. Tap the save icon  to save the new temperature set-point.

Geri will then ask to apply and then confirm the new setting.

5. Tap the confirm icon  to apply the new setting.
6. Within ten seconds of applying any changes, press and hold the multi-function button located at the rear of the corresponding chamber for one second (see below).



After the multi-function button has been pressed, the new temperature set-point is confirmed and applied. The following graphic will be displayed on the touchscreen:

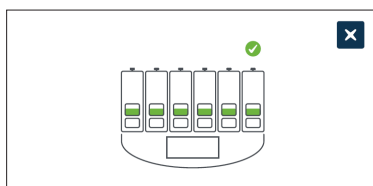

NOTE:





- The temperature alarm is temporarily suspended until the new temperature set-point is reached.
- As an additional confirmation of the new temperature set-point, press the multi-function button behind the chamber to display the set-points for that chamber. The new temperature set-point should be displayed. If not, repeat the above steps.

4.4.2. CO₂ Range Set-Point **CAUTION:**

To confirm a new CO₂ range set-point, the multi-function button at the rear of the chamber must be pressed and held within ten seconds of applying any changes.

The CO₂ range is the acceptable working range of CO₂ in each chamber. When Geri detects CO₂ levels beyond this range an alarm is triggered (see “8.3.3. Gas Alarm” on page 75). The default CO₂ range has a high set-point of 7% and a low set-point of 5%.

To change the CO₂ range set-points:

1. Locate the appropriate chamber on the incubator parameters screen.
2. Tap the current CO₂ range set-point field (located next to the CO₂ icon ) to select the CO₂ range set-points to be changed.
3. Use the arrow icons   to adjust the CO₂ range set-points as required.
4. Tap the save icon  to save the new CO₂ range set-points.

Geri will then ask to apply and then confirm the new setting.

5. Tap the confirm icon  to apply the new setting.
6. Within ten seconds of applying any changes, press and hold the multi-function button located at the rear of the corresponding chamber for one second (see below).



After the multi-function button has been pressed, the new CO₂ range set-points are confirmed and applied. The following screen will be displayed on the touchscreen:

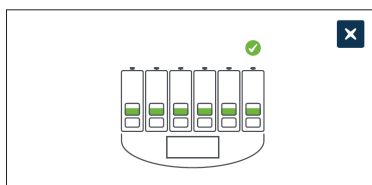

NOTE: As an additional confirmation of the new CO₂ range set-points, press the multi-function button located behind the chamber to display the set-points for that chamber. The new CO₂ range set-points should be displayed. If not, repeat the above steps.

4.4.3. Humidity Alarm On/Off Switch





CAUTION:

- Humidity impacts on the performance of the Geri chamber CO₂ sensor.
- Each time the incubator environment is changed from dry to humid or vice versa, the Geri chamber CO₂ sensor reference point should be reset (see “CO₂ Reference Point & Calibration” on page 29).
- To confirm that the humidity alarm has been switched on or off, the multi-function button at the rear of the chamber must be pressed and held within ten seconds of applying any changes.

Each chamber's humidity alarm can be switched on or off as required. When a chamber's humidity alarm is switched off, the humidity alarms for that chamber will no longer function. The default position for each chamber is on.

To switch a chamber's humidity alarm on or off:

1. Locate the appropriate chamber on the incubator parameters screen.
2. Slide the switch located next to the humidity icon  to on  or off  as required.

Geri will then ask to apply and then confirm the new setting.

3. Tap the confirm icon  to apply the new setting.
4. Within ten seconds of applying any changes, press and hold the multi-function button located at the rear of the corresponding chamber for one second (see below).



After the multi-function button has been pressed, the new humidity alarm setting is confirmed and applied. The following screen will be displayed on the touchscreen:

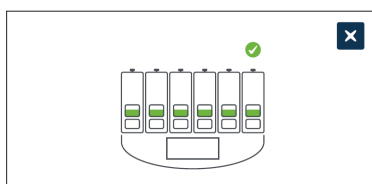

4.4.4. Chamber On/Off Switch





CAUTION:

To confirm that a chamber has been switched on or off, the multi-function button at the rear of the chamber must be pressed and held within ten seconds of applying any changes.

Each chamber can be switched on or off as required. When a chamber is switched off, the heating elements and alarms for that chamber will no longer function. The default position for each chamber is on.

To switch a chamber on or off:

1. Locate the appropriate chamber on the incubator parameters screen.
2. Slide the switch located next to the power icon  to on  or off  as required.

Geri will then ask to apply and then confirm the new setting.

3. Tap the confirm icon  to apply the new setting.
4. Within ten seconds of applying any changes, press and hold the multi-function button located at the rear of the corresponding chamber for one second (see below).

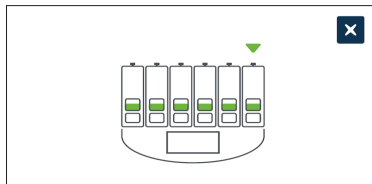

After the multi-function button has been pressed, the new on/off setting is confirmed and applied. The following screen will be displayed on the touchscreen:

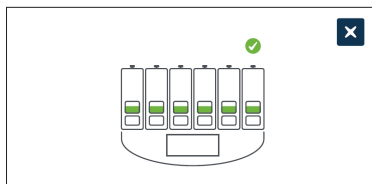



4.5. Z-Stack Settings (Focal Plane)

Every time a time-lapse image is taken, Geri is able to record up to 11 images at different focal planes (five above and five below the core image).

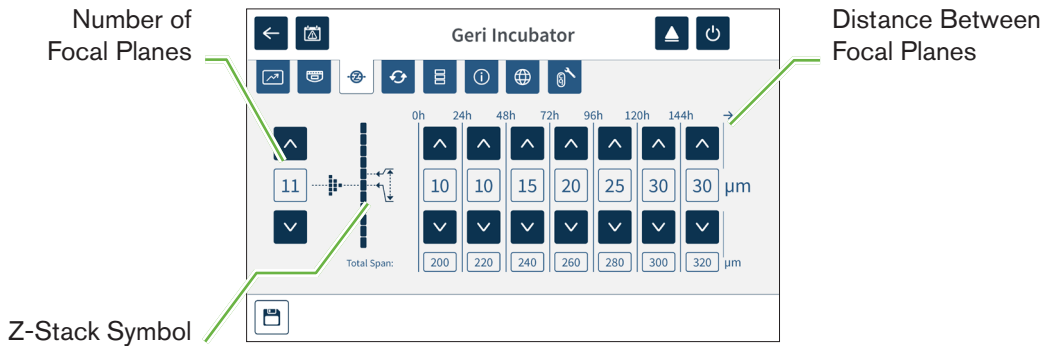

From the basic incubator and software settings screen, tap the z-stack (focal plane) settings icon .



To change the number of recorded focal planes:

1. Use the arrow icons   located to the left of the z-stack symbol to adjust the number of focal planes as required. The number of focal planes is an odd number between 1 and 11.
2. Tap the save icon  to save and apply the new settings.

To change the distance (μm) between focal planes:

1. Use the arrow icons   located to the right of the z-stack symbol to adjust the distance as required.
2. Tap the save icon  to save and apply the new settings.

4.6. Cycle Type Parameters

All time-lapse videos generated by Geri are standardized by starting at the insemination time. By using this standardized starting point, the time-elapsed measurements between different videos can be compared. From the basic incubator and software settings screen, tap the cycle type parameters icon  to access the cycle type parameters screen.

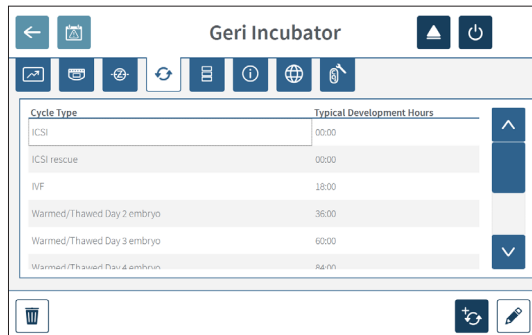

When an embryo is first placed in Geri, the actual time elapsed from insemination will differ depending on the cycle type selected. The cycle type setting is used when an embryo is first placed in Geri to provide an estimation of the development time elapsed since insemination. The default cycle types are:

Cycle Type	Estimated Time Elapsed Since Insemination (Hours)
ICSI	0
IVF	18
Warmed/Thawed Day 2 Embryo	36
Warmed/Thawed Day 3 Embryo	60
Warmed/Thawed Day 4 Embryo	84
Warmed/Thawed Day 5 Embryo	108
Warmed/Thawed Day 6 Embryo	132
ICSI Rescue	0

Before recording images, cycle type and default hours can be confirmed and adjusted to better approximate the actual insemination time.



To add a new cycle type:

1. Tap the add new cycle type icon .
2. Enter the new cycle type name using the on-screen keyboard.
3. Enter the development time in hours and minutes using the on-screen keyboard.
4. Tap enter to save and apply the new cycle type.

To edit an existing cycle type:

1. To select, tap the cycle type to be changed.
2. Tap the edit icon  and change the cycle type name and default development time as required.
3. Tap enter to save and implement the edited cycle type.

To delete an existing cycle type:

1. To select, tap the cycle type to be deleted.
2. Tap the delete icon .
3. Tap the confirm icon  to confirm deletion.

4.7. Instrument Settings

Tap the adjust date and time parameters icon  to access the instrument settings screen.

**CAUTION:**

To avoid damage to the instrument, do not attach any cables to the network connection unless directed by an authorized service technician.

4.7.1. Date & Time

To edit the date and time:

1. Tap the adjust time icon  from the instrument settings screen to edit the system date and time. The Windows date and time setting pop-up window is displayed.
2. Adjust the date and time as required.
3. Tap apply, then tap the OK button to confirm and apply the new date and time setting.

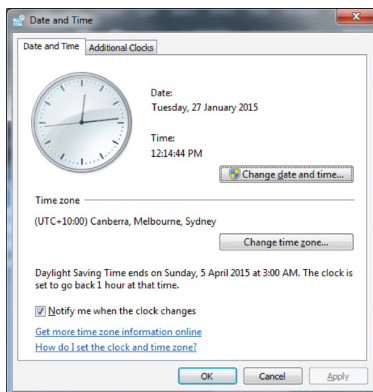

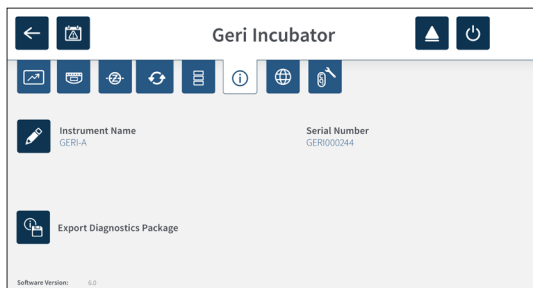

4.8. Incubator Information (Including Instrument Name)

The incubator information screen displays information about the incubator, including the instrument name, serial number, export diagnostics package and software version. Tap the information icon  to access the incubator information screen.



When two or more Geri instruments are being used, it is possible to assign each instrument an individual name to help distinguish between them.

To edit the instrument name:

1. Tap the edit icon  located next to the instrument name field.
2. Use the on-screen keyboard to adjust the instrument name as required.
3. Tap the save icon  to save and assign the new instrument name.

Geri Diagnostics Package:

The Geri diagnostics package contains a set of technical logs recording Geri incubator performance. The logs in the package are used by Genea Biomedx technical personnel to monitor and identify technical issues related to the incubator. The diagnostics package should be exported to an external storage device via the USB port by the laboratory administrator upon request from Genea Biomedx.

To export a diagnostics package:

See “7.11.8. Exporting Diagnostics Package” on page 69.

NOTE:

As the logs accumulate large volumes of information:

- ensure that the external USB storage device to be used has a minimum of 10 GB of free space to be allocated to the diagnostics package
- exporting the diagnostics package may take over 20 minutes.

4.9. Language Localization



CAUTION:

A change in the user interface language may cause an active recording session to skip an image during the Geri application restart.

The default user interface language for Geri is English, however, Geri also supports multiple other languages. The user interface can be displayed in the selected language with the following translation exceptions:





- Cycle types will not be translated and can be defined manually by the user.
- Dates will always be displayed in the format DD-MMM-YYYY with the name of the month always displayed in English.
- Any manual input (such as patient names) can be entered in the desired language at any time regardless of the selected user interface language.



To change the user interface language:

1. Tap the settings icon  from the homescreen. The basic incubator and software

settings screen is displayed and defaults to the incubator parameters (graphics) tab.

2. Tap the Localization icon . The incubator Localization screen is displayed.
3. Select the desired language from the languages drop-down menu.
4. Tap the save icon  to save any changes.
5. Tap the confirm icon  to apply the language change and restart the Geri application or the cancel icon  to cancel.

Once the language change has been confirmed, the Geri application automatically restarts and the selected language will then be displayed on the user interface.

4.10. CO₂ Reference Point & Calibration



WARNING:



- Ensure the chamber is empty (no embryos) before calibrating the CO₂ reference point.
- Setting the CO₂ reference point should not be performed while the chamber is purging, as this will result in an incorrect sensor calibration and a false alarm will be triggered.
- The set reference point is in %CO₂, if using an independent sensor reading in ppm it must be converted to %CO₂.
- To confirm that a chamber CO₂ reference point setting has been performed the multi-function button at the rear of the chamber must be pressed and held within ten seconds of applying any changes.
- When switching the instrument or chamber/s off, it is important to remove the Geri water bottle/s and allow the chamber/s to finish purging. Failure to do so may cause condensation in the chamber which can damage the CO₂ sensor.
- Continually changing the incubator environment between dry and humid is not recommended.

Each Geri chamber is fitted with a Non-Dispersive Infrared (NDIR) CO₂ sensor that monitors the CO₂ level in the chamber. As this sensor can be influenced by the humidity level in the chamber, the sensors require calibration of the CO₂ reference point when changing the incubator environment between dry and humid, or vice versa. The CO₂ sensor stabilization time commences when the chamber lid is opened/closed.



4.10.1. Calibrating the CO₂ Reference Point

1. Identify the expected CO₂ concentration in the chamber. This may be:
 - the %CO₂ in a pre-mixed gas cylinder as indicated in its Certificate of Analysis
 - the %CO₂ set on an external gas mixer attached to Geri and/or
 - the %CO₂ reading from a diffusion type independent CO₂ sensor (see “2.4. Rear of the Instrument” on page 6). **NOTE:** If the reading is displayed as ppm, it will require conversion to %CO₂.

NOTE: Use of a diffusion type independent CO₂ sensor provides the ability to calibrate the Geri chamber CO₂ sensor against an independent reading.

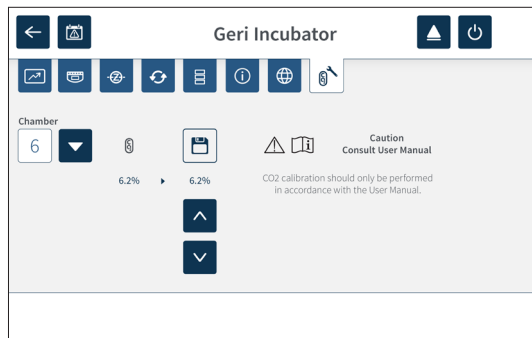
2. Tap the settings icon  from the homescreen. The basic incubator and software settings screen is displayed and defaults to the incubator parameters (graphics) tab.
3. Tap the CO₂ reference point icon . The CO₂ reference point screen is displayed.



4. Select the desired chamber from the drop-down menu.
5. Use the arrow icons   to adjust the CO₂ reference point to match the reading identified earlier.
6. Tap the save icon  to save any changes.
7. Press the multi-function button located at the rear of the corresponding chamber for one second to confirm.

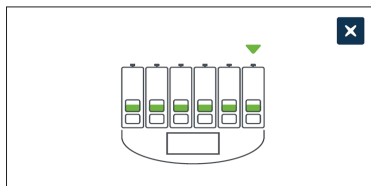

4.10.2. Switching the Chamber Environment from Dry to Humid

NOTE: This process should only be performed once, as continually changing between dry and humid environments is not recommended.

1. Fill the desired number of Geri water bottles to the maximum fill line and add to each chamber requiring humidity (ensure no embryos are in the chamber/s).
2. Enable the humidity alarm for the chamber (see “4.4.3. Humidity Alarm On/Off Switch” on page 21).
3. Leave the chamber closed and uninterrupted for at least three days while the CO₂ sensor stabilizes. **NOTE:** During stabilization, the chamber must be empty of patients and the CO₂ range set-point should be increased to 3%–15% to avoid false alarms (see “4.4.2. CO₂ Range Set-Point” on page 20).
4. After three days, set the CO₂ reference point on Geri to match the CO₂ reading from the CO₂ cylinder supplier’s COA or from an external CO₂ reader (see “4.10.1. Calibrating the CO₂ Reference Point” on page 29). No humidity alarm is expected to have been triggered during the stabilization period.
5. Return the Geri CO₂ range set-point to your lab protocol.

The humidified Geri chamber is now ready for clinical use.

4.10.3. Switching the Chamber Environment from Humid to Dry

NOTE: This process should only be performed once, as continually changing between humid and dry environments is not recommended.

1. Disable the chamber's humidity alarm (ensure no embryos are in the chamber) (see "4.4.3. Humidity Alarm On/Off Switch" on page 21).
2. Remove the Geri water bottle from the chamber.
3. Leave the chamber closed and uninterrupted for at least three days while the CO₂ sensor stabilizes. **NOTE:** During stabilization, the chamber must be empty of patients and the CO₂ range set-point should be increased to 3%–15% to avoid false alarms (see "4.4.2. CO₂ Range Set-Point" on page 20).
4. After three days, set the CO₂ reference point on Geri to match the CO₂ reading from the CO₂ cylinder supplier's COA or from an external CO₂ reader (see "4.10.1. Calibrating the CO₂ Reference Point" on page 29). No humidity alarm is expected to have been triggered during the stabilization period.
5. Return the Geri CO₂ range set-point to your lab protocol.

The dry Geri chamber is now ready for clinical use.

4.10.4. Maintenance of the CO₂ Reference Point

- If the chamber is maintained at high humidity by regularly changing the Geri water bottle, the CO₂ reference point should only need to be recalibrated once every three months. For maintenance of the CO₂ reference point, follow the instructions under "4.10.2. Switching the Chamber Environment from Dry to Humid" on page 30. **NOTE:** The required CO₂ sensor stabilization time is only 12 hours.
- If the chamber is maintained as a dry environment, the CO₂ reference point should only need to be recalibrated once every three months. For maintenance of the CO₂ reference point, follow the instructions under "4.10.3. Switching the Chamber Environment from Humid to Dry" on page 31. **NOTE:** The required CO₂ sensor stabilization time is only 30 minutes.

4.11. Basic Image Settings

The basic image settings screen is used to adjust the image settings for each chamber. To access the basic image settings screen, tap the basic image settings icon  from the chamber screen (see “7.6. Chamber Screen” on page 54).

Icon	Image Setting
	Camera Focus.
	Image Contrast.
	Camera Alignment.

The basic image settings will timeout after three minutes of inactivity and a timeout pop-up window will appear.

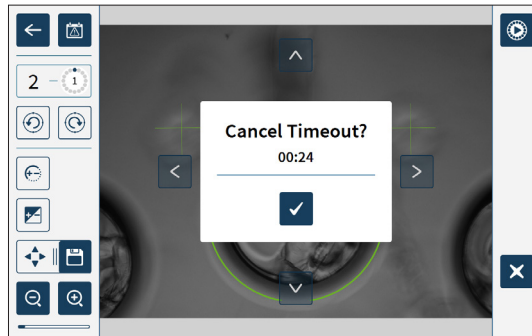



To cancel the timeout and continue to make adjustments to the basic image settings, tap the confirm icon .

If the timeout completes, the basic image settings will revert back to the previous settings and any unsaved changes will be lost.

4.11.1. Camera Focus

To adjust the camera focus:

1. Tap the camera focus icon  (the save icon  will appear next to the camera focus icon).

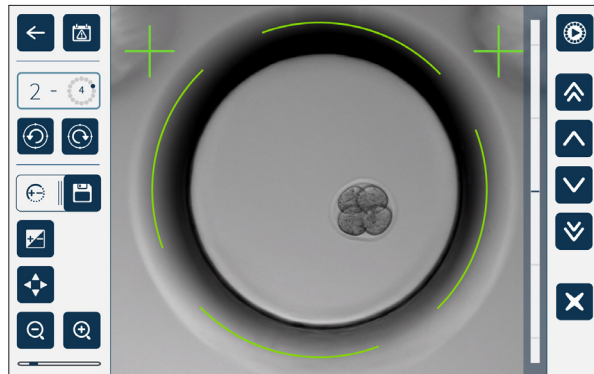

2. Use the arrow icons     to adjust the camera focus as required.



The status bar to the right of the image displays the current camera focus (light-blue bar) and the adjusted camera focus (dark-blue bar).

3. Tap the save icon  to save the new camera focus setting.



NOTE: The same focus setting is used for all micro-wells in that chamber.

4.11.2. Image Contrast

To adjust the image contrast:

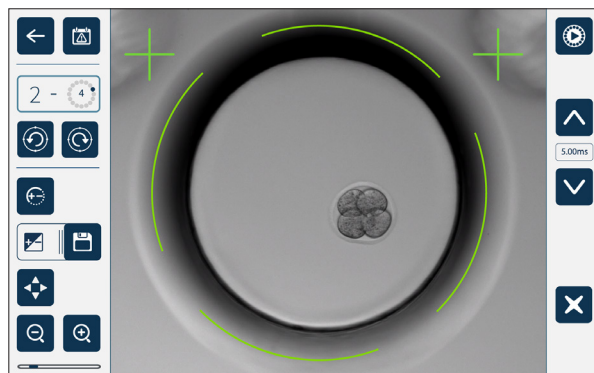
1. Tap the image contrast icon  (the save icon  will appear next to the image contrast icon).





2. Use the arrow icons   to adjust the image contrast as required.
3. Tap the save icon  to save the new image contrast setting.





NOTE: The same image contrast setting is used for all micro-wells in that chamber.

4.11.3. Camera Alignment

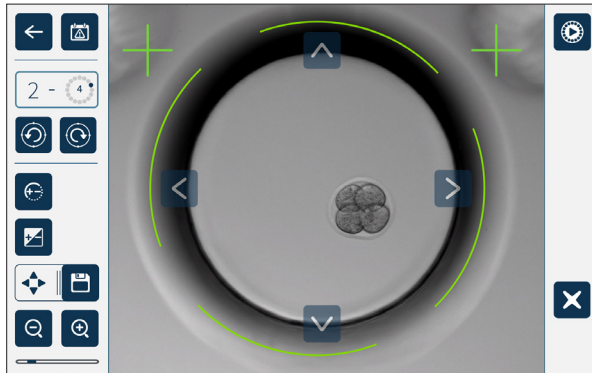
To adjust the camera alignment:

1. Tap the camera alignment icon  (the save icon  will appear next to the camera alignment icon).



2. Use the arrow icons     to move the displayed image to the desired camera alignment.
3. Tap the save icon  to save the new camera alignment.

NOTE: The same camera alignment setting is used for all micro-wells in that chamber.

4.12. Installation & Set-up Checklist

When installing Geri, check that:















- all ordered Geri items have been supplied
- the supplied power cord is correct for country-specific power requirements
- Geri is placed in an appropriate location
- the correct gas regulator has been obtained
- all gas connections have been made and checked
- a gas filter has been installed in each chamber
- a Geri water bottle has been installed in each chamber (if a humid chamber environment is to be used)
- the gas regulator is set to 160 kPa
- an external USB drive is attached to the Geri USB port
- Geri has been powered on
- the basic incubator and software settings have been reviewed and adjusted as required
- the basic image settings have been reviewed and adjusted as required
- if required, Geri is connected to an external monitoring/alarm system
- Geri has been run under normal operating conditions for at least 24 hours before any clinical usage.

**CAUTION:**

It is the owner's responsibility to ensure that the Geri system, including all required consumables and accessories, has been validated for use in their facility before the first clinical use and after system maintenance.

5. ABOUT THE CONSUMABLES

The following symbols appear on the Geri instrument and Geri consumables:

Symbol	Title	*ISO 15223-1 Reference #
	Date of Manufacture	2497
	Batch Code	2492
	Serial Number	2498
	Reference	2493
	Sterilized using irradiation	2502
	Use By	2607
	Keep Away from Sunlight	0624
	Do Not Resterilize	2608
	Single Use Only, Do Not Re-Use	1051
	Caution, Consult the User Manual	1641
	Do Not Use if the Package is Damaged	2606
	This Instrument is Subject to Laws Regarding the Disposal of Electronic Medical Equipment as Outlined in the WEEE Directive (2006/96/EC)	
	Product conforms to the Medical Device Directive 93/42/EEC (BSI)	
	Federal Law (USA) restricts this device to sale by or on the order of a licensed physician or other healthcare practitioner	

5.1. Geri Dish

REF GERI-DSH-20

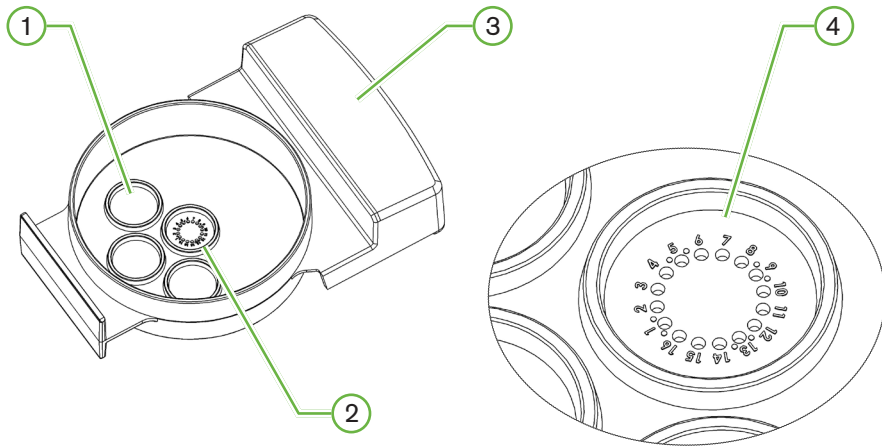

① Wash Well

The three outer wash wells can hold media for washing embryos.

② Central Well

The central well contains 16 high-precision and high-clarity micro-wells for the storage of embryos during incubation.

③ Geri Dish Handle

The Geri dish has a flat, broad handle that is also used for patient-identification labels.

④ Micro-Well

Each numbered micro-well has a base diameter of 430 μm and depth of 400 μm , and is designed to contain a single embryo.

WARNING:

When using the Geri dish:

- It is the owner's responsibility to ensure that any embryo culture dishes used in Geri have been validated for use in their facility.
- The use of deep, steep-walled wells may increase the risk for pipetting damage to embryos during loading and unloading procedures.
- Follow laboratory standard operating procedures for preparing, using and disposing of embryo culture dishes.
- Do not use if the Geri dish pouch is opened, damaged or compromised in any way.
- Always adhere to aseptic technique.
- Inspect the Geri dish for debris or contamination before use and discard the Geri dish if contaminated.
- The Geri dish is single use only. The safety and performance of the Geri dish cannot be assured if it is re-used, re-processed or re-sterilized.
- Do not use the Geri dish if it has passed the expiration date indicated on the label.
- Avoid contacting the Geri dish surface with pipettes or other laboratory equipment.
- Bubbles may form during the Geri dish preparation. If possible, carefully remove any bubbles. If any bubbles remain in the micro-wells, discard the Geri dish.
- Do not touch or contaminate the base of the Geri dish surface directly under the micro-wells.
- Place only one embryo in each micro-well.
- Do not place embryos from more than one patient in the same Geri dish.
- Place the patient identification information on the Geri dish handle using xylene-free permanent markers or labels.
- Do not drop or knock the Geri dish, and take care while holding the Geri dish to avoid any sudden movements that may dislodge the embryos from the micro-wells.



5.1.1. Indications for Use/Intended Use

The Geri Dish is intended to be used for the preparation, storage and imaging of human embryos. The Geri Dish is intended to be used only with the Geri incubator.

5.1.2. Quality Control

Each lot of Geri dishes is tested for:

- SAL (sterility assurance level) of 10^{-6}
- endotoxin by LAL (limulus amoebocyte lysate) test
 - endotoxin level <20 EU/dish
- biocompatibility by MEA (mouse embryo assay) test
 - 1-cell \geq 80% developed to expanded blastocyst stage within 96 hours

All results are provided on lot specific Certificate of Analysis that are available upon request.

5.1.3. Consumable Provided

The Geri dish is supplied with a lid and is provided individually wrapped inside a pouch in a box containing 20 dishes. The Geri dish is supplied sterile and is for single use only.

5.1.4. Storage

The Geri dishes must be stored at room temperature in their original packaging, in a closed, dry area away from direct sunlight.

When stored as directed, the Geri dish will be stable until the expiration date shown on the product label. The Geri dish cannot be re-sterilized after opening. The Geri dishes are single use only. Discard after use.

Do not use the product if:

- the packaging appears damaged or the seal is broken
- the expiration date on the product label has passed.

5.1.5. Geri Dish Preparation & Directions for Use

The Geri dish should be prepared in a sterile environment. The lids should remain on the dishes until the dishes are loaded with culture medium and oil. Geri dish preparation should be performed in a laminar flow cabinet using aseptic technique.

NOTE: Avoid touching the micro-well walls and base with the pipette tip to reduce the chance of scratching the plastic.

To prepare a Geri dish:

1. Aspirate 2–3 μL of IVF culture medium with a pipette.
2. Hold the pipette above each micro-well and dispense media until the well is full.
3. Repeat steps one and two until all micro-wells have been filled.
4. Pipette 80 μL of media into the central micro-well, ensuring all micro-wells are covered. The central well has the capacity to hold 80 μL .
5. Check each micro-well and carefully remove any bubbles from the wells by aspirating with a pipette.
6. Pipette 80 μL of media into each outer wash well. Each outer wash well has the capacity to hold 80 μL .
7. Slowly cover all media drops with a minimum of 4 mL of approved IVF culture oil.
8. Equilibrate the media following laboratory standard operating procedures.
9. Ensure that no air bubbles are present (including within each micro-well) prior to incubation.

NOTE: we recommend to cover the media with oil after the micro-wells have been filled with media and checked for air bubbles, as this ensures that the micro-wells contain media, not oil.

NOTE: It is not recommended that embryos or dishes from two patients be placed in the same chamber.

To load embryos into a Geri dish:

1. Inspect the dish and remove any bubbles.
2. Use a pipette to place one embryo into a micro-well, taking care to avoid creating any bubbles. Only move one embryo at a time and do not place more than one embryo into a micro-well.
3. Inspect the dish to ensure all embryos are sitting at the base of the micro-well. Remove any bubbles.
4. Place the dish into the Geri instrument.

To place a Geri dish into the Geri instrument: see “7.5.1. Placing & Removing a Geri Dish” on page 52.

To remove embryos from a Geri dish:

1. Place the pipette tip near the top of the micro-well and gently aspirate. **NOTE:** Avoid touching the walls or base of the micro-well with the pipette tip.
2. Rinse the embryo using the outer wash wells as required.

NOTE: The procedures identified are in part to prevent damage during the retrieval process.

5.2. Geri Water Bottle

REF GERI-WAT-12

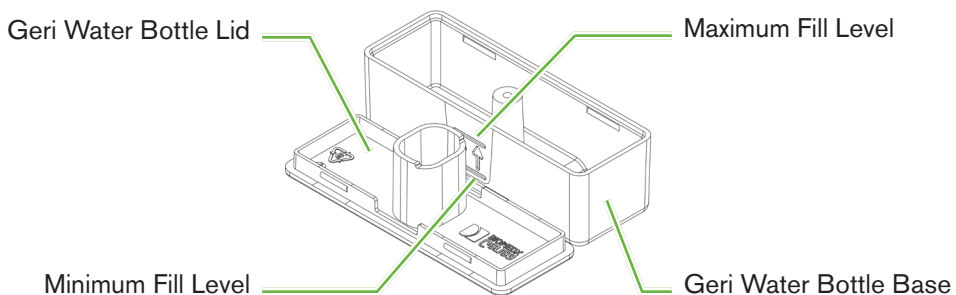

5.2.1. Indications for Use/Intended Use

The Geri water bottle is a single use consumable to be used in a single Geri chamber. Correct use of the Geri water bottle will provide a humidified environment inside a Geri chamber.

5.2.2. Consumable Provided

The Geri water bottle is supplied individually wrapped inside a pouch in a box containing 12 water bottles.

**WARNING:**

- Do not use if the Geri water bottle pouch is opened, damaged or compromised in any way.
- Do not fill the Geri water bottle above the maximum fill level.
- Always adhere to aseptic technique.
- Inspect the Geri water bottle for debris or contamination before use and discard if contaminated.
- Do not use the Geri water bottle if it has passed the expiration date shown on the label.
- The Geri water bottle is single use only. The safety and performance of the Geri water bottle cannot be assured if it is re-used, re-processed or re-sterilized.
- The expected time for a full Geri water bottle (from the maximum fill level) to reach the minimum fill level is two (2) weeks.
- It is recommended to use warmed or room temperature sterile water to fill the water bottle.
- Do not drop or knock the Geri water bottle.
- Ensure that no water has been spilled or splashed on the outside of the Geri water bottle or in the Geri chamber as this can cause condensation that will impact the quality of images taken by Geri.
- It is recommended that oil is used to culture, even in a humidified chamber as the humidity will not eliminate the evaporation of media, it will only reduce the evaporation rate.
- When switching the instrument or chamber/s off, it is important to remove the Geri water bottle/s and close the lid to allow the chamber/s to finish purging. Failure to do so may cause condensation in the chamber which can damage the CO₂ sensor. If switching the instrument off, please follow the instructions in “Powering Off” on page 69.

5.2.3. Storage

The Geri water bottles must be stored at room temperature in their original packaging, in a closed, dry area away from direct sunlight.

When stored as directed, the Geri water bottles will be stable until the expiration date shown on the product label. The Geri water bottles cannot be re-sterilized after opening. The Geri water bottles are single use only. Discard after use.

Do not use the product if:

- the packaging appears damaged or the seal is broken
- the expiration date on the product label has passed.

5.2.4. Geri Water Bottle Preparation & Directions for Use

NOTE: Take care not to spill any water.

To prepare a Geri water bottle:

1. Remove the lid from the base of the Geri water bottle, by holding the short sides of the Geri water bottle.
2. Using a thick pipette, fill the Geri water bottle to the maximum fill level with warmed or room temperature sterile water.

3. Attach the Geri water bottle lid to the base of the Geri water bottle, ensuring they are securely clipped together.
4. Ensure that no water has been spilled or splashed on the outside of the Geri water bottle or in the Geri chamber before placing the Geri water bottle into the water bottle position in the Geri Chamber.

See “7.5. Accessing a Chamber” on page 51 and “7.5.2. Placing & Removing a Geri Water Bottle” on page 53.

6. ABOUT THE ACCESSORIES

6.1. Filter

REF GERI-FIL-50

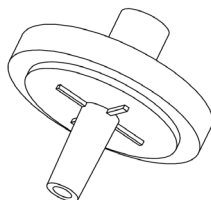

6.1.1. Indications for Use/Intended Use

The filter is used to improve the purity of the gas as it enters each chamber. The filter is located inside each chamber at the rear.

Each filter has a polypropylene housing containing a polypropylene-reinforced polytetrafluoroethylene (PTFE) membrane with a 0.20 µm pore size. It has a Luer lock inlet and Luer slip outlet.

6.1.2. Accessory Provided

The filter is supplied individually wrapped inside a pouch in a box containing 50 filters.

6.1.3. Storage

The filters must be stored at room temperature in their original packaging, in a closed, dry area away from direct sunlight.

When stored as directed, the filters will be stable until the expiration date shown on the product label. The filters cannot be re-sterilized after opening. The filters are single use only. Discard after use.

Do not use the product if:

- the packaging appears damaged or the seal is broken
- the expiration date on the product label has passed.

6.1.4. Filter Preparation & Directions for Use



See “3.4.6. Gas Filter” on page 14.



CAUTION:

Do not re-use the filter. The performance of the filter in improving the purity of the gas may be compromised.

7. OPERATING GERI

	<p>CAUTION:</p> <p>It is the owner's responsibility to ensure that the Geri system, including all required consumables and accessories, has been validated for use in their facility before the first clinical use and after system maintenance.</p>
	<p>WARNING:</p> <p>It is the owner's responsibility to ensure that all users of Geri:</p> <ul style="list-style-type: none"> ▪ are trained in all laboratory safety procedures, including the handling of hazardous materials ▪ have read and understood the instructions and warnings contained in this user manual ▪ have received adequate training in the correct operation of the instrument.

7.1. Preparing Geri for Use

Before using Geri to culture embryos, check that:

- the chamber to be used has been turned on
 - It is recommended that each new chamber to be used is turned on at least 24 hours before use to enable equilibration in all conditions encountered in a 24-hour period.
 - **To activate a chamber:** see “4.4.4. Chamber On/Off Switch” on page 22.
- the temperature set-point for each chamber is correct
 - The current set-point can be quickly displayed by pressing the multi-function button at the rear of the chamber. The temperature set-point is displayed on the chamber screen for one second before reverting to the current temperature in the chamber.
 - **To adjust the temperature set-point for a chamber:** see “4.4.1. Temperature Set-Point” on page 19.
- all gas connections have been made and that there is gas flow into the chamber (see “3.4. Gas Supply” on page 11)
- the CO₂ reference point is set (see “4.10. CO₂ Reference Point & Calibration” on page 29)
- if required, the humidity alarm is switched on (see “4.4.3. Humidity Alarm On/Off Switch” on page 21)
- if required, Geri has been correctly connected to an external monitoring or alarm system
- an external USB drive is attached to the Geri USB port.

7.2. Homescreen

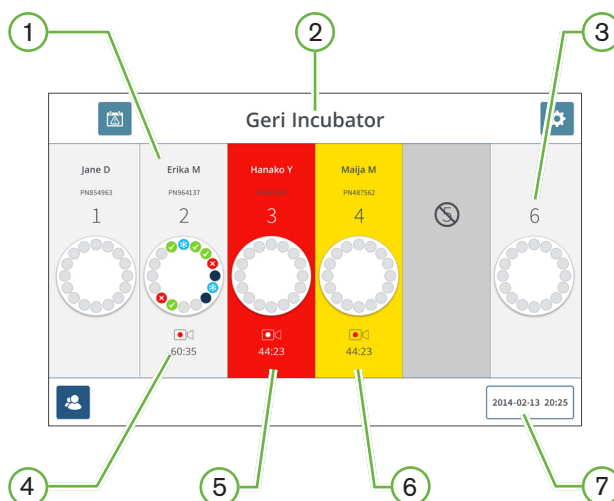

The homescreen displays the following information:

- ① **Patient Name and ID**
- ② **Instrument Name**
- ③ **Chamber Number**

The homescreen chamber numbers correspond to physical chambers of Geri.

- ④ **Recording Icon**

If recording, the recording icon appears together with the estimated time since insemination in hours and minutes.

- ⑤ **Alarm Triggered**



If an alarm is triggered, the affected chamber will flash red and an alarm will sound (see “8. Alarms & Warnings” on page 71).

- ⑥ **Warning Triggered**

If a warning is triggered, the affected chamber will flash yellow (see “8. Alarms & Warnings” on page 71).

- ⑦ **Current System Date and Time**

The following icons are displayed on the homescreen:

Icon	Description
	Alarm History: Tap this icon to view the alarm history and all current alarms and warnings.
	Settings: Tap this icon to view and edit incubator and software settings.
	Patient List: Tap this icon to view lists of added/unallocated patients, recording patients and historical patients. Patient information can be added or edited from this screen.

7.3. Chamber Lid Screen

During normal operation the chamber lid displays the following information:

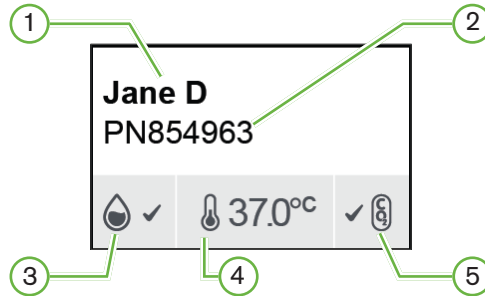

- ① Patient Name
- ② Patient ID
- ③ Current Humidity Status (when enabled)
- ④ Current Temperature
- ⑤ Current CO₂ Status

The individual chamber settings (see below image) can also be viewed by pressing the multi-function button located at the rear of each chamber.

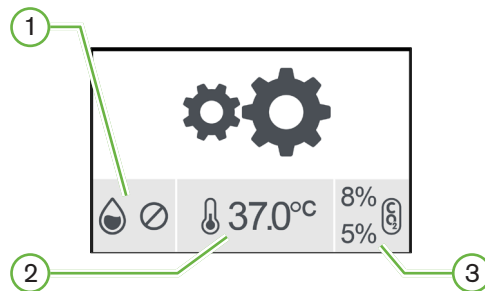

- ① Humidity Status
- ② Temperature Set-Point
- ③ CO₂ Alarm Thresholds

The chamber lid screen will show when Geri performs a chamber purge. During the chamber purge, the background color of the CO₂ status on the chamber lid screen will change to blue (see below image).

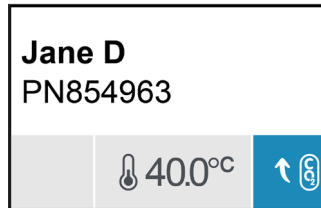

The chamber lid screen also shows indicators for most alarms and warnings. For further information on alarms and warnings, see “8. Alarms & Warnings” on page 71.



If the chamber has been switched off, the chamber lid screen will show the chamber off icon .

7.4. Adding & Editing Patient Details

7.4.1. Adding New Patient Details

Tap the patient list icon  from the homescreen.

The patient list can be filtered as follows:

- Tap the unallocated patients icon  to show unallocated patients
- Tap the allocated patients icon  to show current active patients
- Tap the historical patients icon  to show historical patients.

To add a new patient:

1. Tap the add patient icon .
2. Use the on-screen keyboard to input the new patient name, patient ID and date of birth (DOB).



3. Tap  to save and add the new patient details.



7.4.2. Editing Patient Details

To edit patient details:

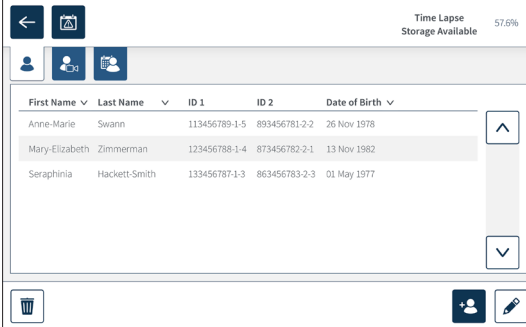
1. Tap the patient list icon  from the homescreen. The unallocated patient list is displayed.
2. Tap the patient name to be edited.



First Name	Last Name	ID 1	ID 2	Date of Birth
Anne-Marie	Swann	113456789-1-5	893456781-2-2	26 Nov 1978
Mary-Elizabeth	Zimmerman	123456788-1-4	873456782-2-1	13 Nov 1982
Seraphinia	Hackett-Smith	133456787-1-3	863456783-2-3	01 May 1977

3. Tap the edit icon .
4. Use the on-screen keyboard to edit the patient details as required (see “7.4.1. Adding New Patient Details” on page 48).
5. Tap the save icon  to save and update the patient details.

7.4.3. Adding a Geri Assess 2.0 Enabled Patient on Geri Connect

As Geri Assess 2.0 is reliant on the availability of licenses, a patient to be Geri Assess 2.0 enabled must be 1) added to the Patient List and 2) Geri Assess 2.0 enabled in the connected Geri Connect server and then once the patient details have synchronized to the Geri instruments 3) be allocated to a chamber on Geri. See “QFRM1020 Geri Connect & Geri Assess User Manual - 4.1.6. Adding a Geri Assess 2.0 Enabled Patient” and “7.4.4. Allocating a Patient to a Chamber” on page 50.

7.4.4. Allocating a Patient to a Chamber

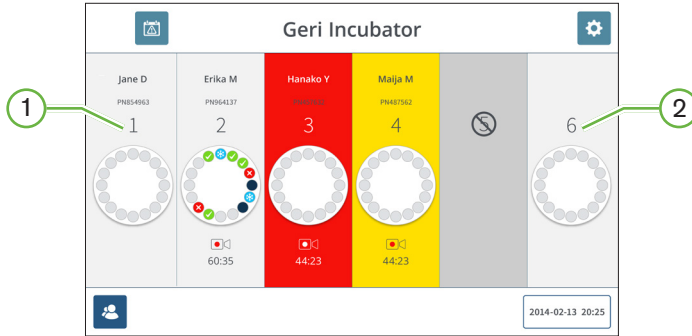

- ① Empty and Allocated Chamber
- ② Empty and Unallocated Chamber

To allocate a patient to a chamber:

1. From the homescreen, tap an empty and unallocated chamber. The chamber screen is displayed.

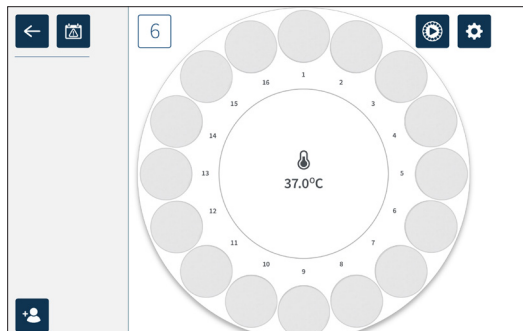

2. Tap the add patient icon . A list of unallocated patients is displayed.
3. To select, tap the patient name that is to be allocated.
4. Tap the allocate to chamber icon to save and allocate the patient name to the chamber. **NOTE:** The number in the allocate to chamber icon represents the chamber number being allocated.

The chamber screen and homescreen will now show the patient details on the allocated chamber.

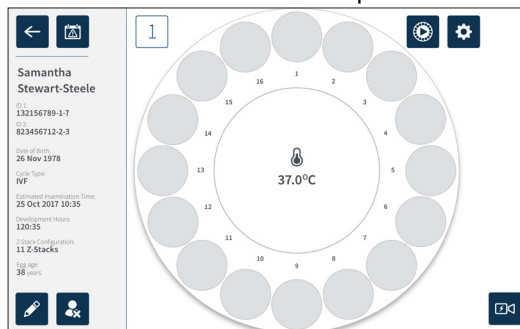

7.5. Accessing a Chamber



WARNING:

To minimize the risk of embryo displacement, always take care when closing the chamber lid and avoid bumping or knocking Geri.

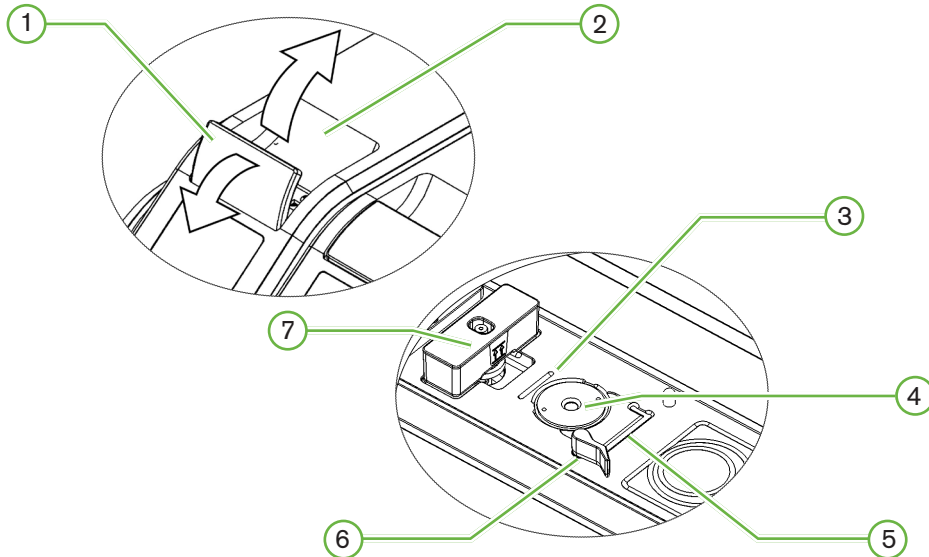

① **Green Lid Latch**

② **Chamber Lid**

③ **Rear Edge Dish Groove**

The rear edge dish groove provides a guide for the rear edge of the Geri dish.

④ **Camera Position**

Each chamber has a dedicated camera to take images of the embryo.

⑤ **Front Edge Dish Groove**

The front edge dish groove provides a guide for the front edge of the Geri dish.

⑥ **Dish Lock**

The dish lock secures the Geri dish in its correct position. **To open:** rotate the dish lock to the left. **To close:** rotate to the right.

⑦ **Water Bottle Position**

The groove provides an exact placement for the Geri water bottle above the Geri filter.

To access a chamber:

1. Lift the green lid latch to unlock the chamber lid.
2. Lift the chamber lid to the vertical position to minimize the risk of the chamber lid falling back to its closed position.

7.5.1. Placing & Removing a Geri Dish

To place a Geri dish into a chamber:

1. Open the chamber by lifting the green lid latch.
2. Check that the dish lock is in the open position (see “7.5. Accessing a Chamber” on page 51).
3. Carefully place the dish into the camera position, ensuring that the dish's front edge corresponds with the front edge dish groove of Geri and the dish's rear edge corresponds to the rear edge dish groove of Geri.
4. Close the dish lock by gently rotating it to the right until it touches the Geri dish.
5. Check that the dish's front and rear edges are aligned to their corresponding grooves. If the edges are no longer aligned, return the dish lock to the open position and re-position the dish before repeating steps three and four.
6. Close the chamber lid and lightly push down on the green lid latch to lock the chamber lid in place and ensure a fully sealed environment for the embryo.

After a dish is placed in a chamber, the quick preview icon  (see “7.6. Chamber Screen” on page 54) can be used to take an immediate image of each micro-well to ensure that the basic image settings of alignment, contrast and focus are sufficient to start recording.

**WARNING:**

If a chamber is found with the chamber lid latch not fully engaged, the lid should be opened and closed before being re-latched. Opening and closing the lid initiates a purge cycle to ensure the optimal CO₂ environment is re-established as quickly as possible.

To remove a Geri dish from a chamber:

1. Open the dish lock by gently rotating it to the left.
2. Carefully remove the dish.

7.5.2. Placing & Removing a Geri Water Bottle



WARNING:

- Ensure Geri water bottles are removed from each chamber before switching the Geri instrument off.
- The Geri chamber CO₂ reference point should be reset whenever the chamber operating environment changes from dry to humid, or vice versa. When changing from a dry to a humid environment, allow the sensor to stabilize uninterrupted in the humid chamber for at least three (3) days before setting the reference point (see “4.10. CO₂ Reference Point & Calibration” on page 29).

To place a Geri water bottle into a chamber:

1. Ensure a filter is installed in the chamber (see “3.4.6. Gas Filter” on page 14).
2. Fit the filled Geri water bottle to the filter as shown (see “5.2.4. Geri Water Bottle Preparation & Directions for Use” on page 41).

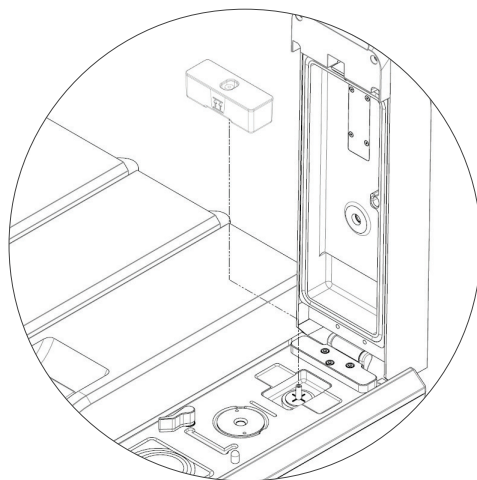

3. Close the chamber lid and lock the green lid latch.
4. Ensure the humidity alarm is enabled (see “4.4.3. Humidity Alarm On/Off Switch” on page 21).

To remove a Geri water bottle from a chamber:

1. Lift the Geri water bottle from the filter.
2. Discard the used Geri water bottle.

7.5.3. Chamber Purge

Whenever a chamber lid is opened and closed, Geri will automatically adjust the temperature and perform a chamber purge to quickly return the chamber to its temperature and gas set-points.

Humidity levels will take longer to return to the level they were before the chamber lid was opened. If the chamber lid has been opened for less than ten seconds and then closed, it will take up to four hours for the chamber to return to a level of 60% relative humidity.

7.6. Chamber Screen



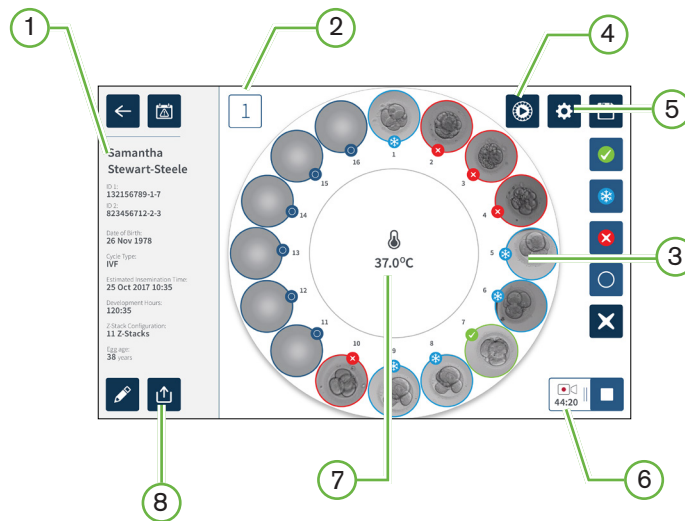







When a chamber is selected from the homescreen, the chamber screen is displayed.



The chamber screen displays the following information:

- 1 Patient Name and Details
- 2 Chamber Number
- 3 Individual Micro-Well Positions
- 4 Quick Preview Icon
- 5 Basic Image Settings Icon
- 6 Active Recording Icon - If recording, this icon appears together with the estimated embryo development time since insemination in hours and minutes.
- 7 Temperature
- 8 Export Icon

The following icons are displayed on the chamber screen:



Icon	Description
	Back: Tap this icon to return to the homescreen.
	Alarm History: Tap this icon to view alarm history and all current alarms and warnings for the chamber.
	Quick Preview: Tap this icon to take an immediate image from each micro-well. This is primarily used to check that basic image settings are correct.
	Basic Image Settings: Tap this icon to view and edit the chamber's basic image settings. See "4.11. Basic Image Settings" on page 32 for more information.
	Multi-Select: Tap this icon to highlight multiple micro-wells.
	Transfer Embryo Tag: Tap this icon to tag an embryo for transfer. Once tagged, the icon changes to  .
	Cryopreservation Tag: Tap this icon to tag an embryo for cryopreservation. Once tagged, the icon changes to  .
	Discard Tag: Tap this icon to tag an embryo for discarding. Once tagged, the icon changes to  .
	Empty Micro-Well Tag: Tap this icon to tag an empty micro-well. Images from these positions will not be exported. Once tagged, the icon changes to  .
	Recording: Tap this icon to start recording images for the chamber.
	Active recording: If recording, this icon appears together with the estimated embryo development time since insemination in hours and minutes.
	Edit: Tap this icon to edit patient details or to assign a cycle type to a patient.
	Unallocate Patient: Tap this icon to remove the patient details from the chamber. This feature does not operate during active recording, it is only available prior to starting recording.
	Stop Recording: Tap this icon to stop recording images. After stop recording is confirmed, the patient is transferred to the historical patient tab.
	Export Data: Tap this icon to export the patient report to an external USB device.

7.7. Recording Embryo Development Time-Lapse Images

7.7.1. Assign Cycle Type & Determine Estimate of Insemination Time

The cycle type is used to estimate the time of insemination in hours and minutes. By providing the same starting point, the time of insemination is used to standardize all generated images and to help determine the focal plane spacing to be used during recording.

To assign a cycle type to a patient:

1. Tap the patient's allocated chamber from the homescreen. The chamber screen is displayed.
2. Tap the edit icon  to edit the patient's details. The patient information screen is displayed (see "7.4.1. Adding New Patient Details" on page 48).
3. Tap the drop-down arrow  located next to the cycle type field to access the drop-down menu and display all cycle types.

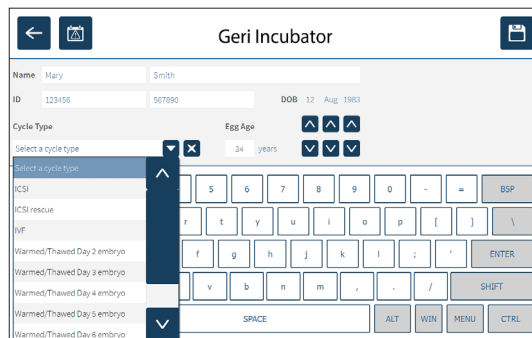

4. Tap the desired cycle type to select.

Based on the cycle type selected, an estimate of the insemination date and time is displayed. Both the date and time can be further adjusted if required.

To adjust the insemination date or time:

1. Tap the date or time to select.
2. Use the arrow keys to adjust.



3. Tap  to save the selections and return to the chamber screen.

To edit the cycle types: see “4.6. Cycle Type Parameters” on page 24.

7.7.2. Start Recording & Empty Well Detection

To start recording embryo images:

From the desired patient's allocated chamber screen:

1. Tap the quick preview icon  to take an image of each well to ensure that the basic image settings of alignment, contrast and focus are sufficient to start recording (to make any adjustments to the basic image settings see “4.11. Basic Image Settings” on page 32).

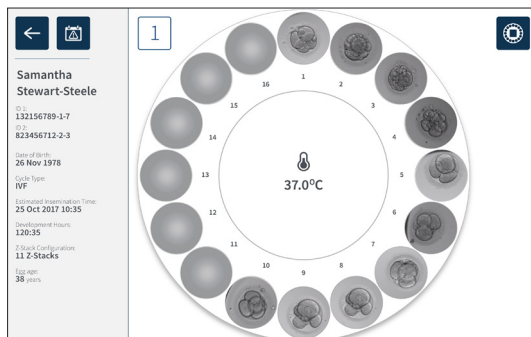

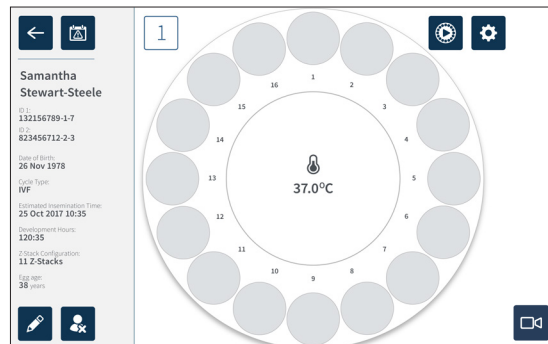

2. Once the image settings are correct, tap the record icon  to start the empty well detection.



A pop-up window is displayed to enable confirmation of the development hours or estimated time since insemination and to start the empty well detection.



- If the details are correct, tap the start empty well detection icon  to start empty well detection. If the details are incorrect, edit the information as required by clicking the cancel icon  and then restarting the empty well detection. If the cancel icon  is tapped, empty well detection will be canceled. The pop-up window will disappear and the patient's allocated chamber screen will be shown.

Geri will take approximately 20 seconds and detect the empty wells as depicted by the rolling ball in the center of the Geri Dish and the text in the top right corner.

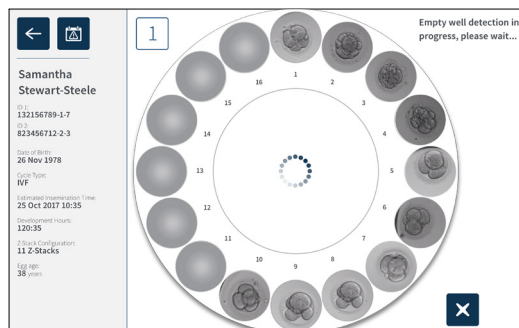

NOTE: If Geri has not detected the correct empty wells, tap on the correct empty wells and then tap the empty well icon in the top right corner. Perform this prior to tapping the record icon.

- Once the empty wells have been detected, tap the record icon  located on the bottom right of the screen.

A pop-up window is displayed to confirm the empty well selection.

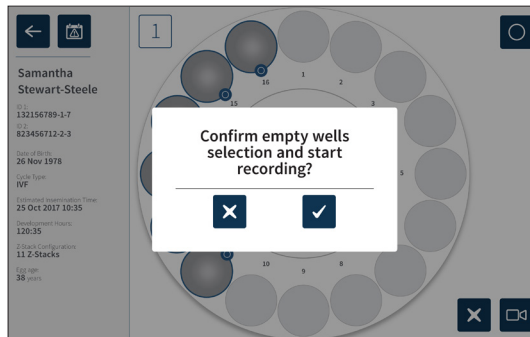

5. Tap the confirm icon to confirm empty wells selection and start recording embryo images.
6. Tap the cancel icon to exit the dialog box without confirming the selection.

Once recording has commenced, the active recording icon  will be displayed on the chamber screen along with the elapsed recording time.

NOTE: If the confirm empty wells and start recording pop-up window is not confirmed within 10 minutes, Geri will automatically start time-lapse recording of all micro-wells and disregard the empty well detection.

NOTE:

- Images are recorded once every five minutes.
- Images can take up to five minutes to appear in the micro-wells depending on the camera position in the image capturing cycle.
- The images will be displayed as the camera moves around to each micro-well.

NOTE: Micro-wells can be tagged as empty within 25 minutes from the start of time-lapse recording, by using the tagging icons on the Chamber screen.

NOTE: Data from micro-wells that are tagged as empty cannot be exported, nor will the data be transferred and synchronized to a connected Geri Connect server.

7.7.3. Stop Recording

To stop image recording:

1. Tap the desired chamber from the homescreen. The chamber screen is displayed.
2. Tap the stop recording icon  located on the bottom right of the screen. The stop recording pop-up window is displayed.

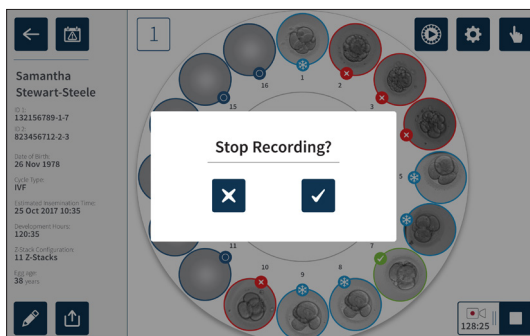

3. Tap the confirm icon  to stop recording.

When image recording is stopped, the patient is no longer considered an active patient and is instead classified as an historical patient.



CAUTION:

Do not tap the Stop Recording icon when temporarily removing a Geri dish for media change. Do not tap the Stop Recording icon until the patient's recording session is complete.

7.8. Micro-Well Screen

To view a specific micro-well, tap the desired micro-well position from the chamber screen. The micro-well screen is displayed.



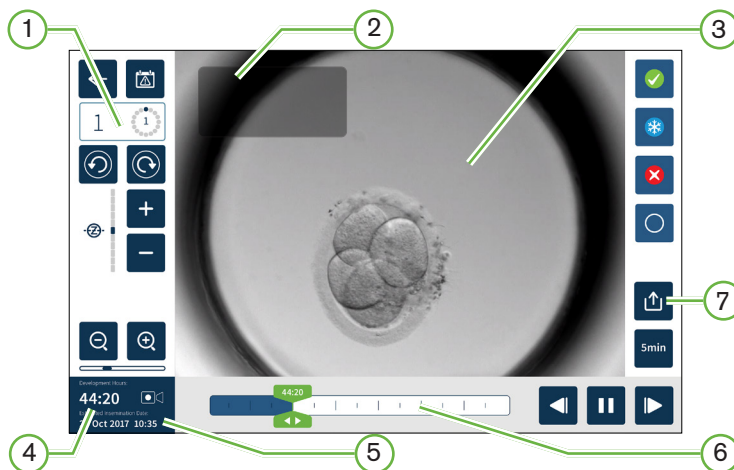



















The micro-well screen displays the following information:





- 1 Chamber Number and Micro-Well Position
- 2 Patient Name and ID
- 3 Embryo Image
- 4 Elapsed Recording Time
- 5 Estimated Insemination Date and Time
- 6 Playback Scroll Bar
- 7 Export Icon

The screen shows the latest available image of the embryo, by default.

The following icons are displayed on the micro-well screen:

Icon	Description
	Back: Tap this icon to return to the chamber screen.
	Alarm History: Tap this icon to view alarm history and all current alarms and warnings for the chamber.
	Display Next Micro-Well: Tap this icon to display images from the next micro-well.
	Display Previous Micro-Well: Tap this icon to display images from the previous micro-well.
	Z-Stack (Focal Plane): Tap  or  to move between z-stack focal planes.
	Zoom In and Zoom Out: Tap  or  to zoom in or zoom out of the image. The bar below these icons represents the zoom range and its current position within that range.
	Playback Scroll Bar Button: Slide this button along the timeline to quickly move between images. The number in the button represents the estimated embryo development time since insemination.
	Play: Tap this icon to start image playback.
	Pause: Tap this icon to pause image playback.
	Image Rewind: Tap this icon while playback is paused to review the previous image.
	Image Advance: Tap this icon while playback is paused to view the next image.
	Playback Speed: Tap this icon to change the playback speed. The default setting is to display an image taken every five minutes. This can be changed to display an image every 10, 30 or 60 minutes.
	Export: Tap this icon to export videos in the current z-plane from the current micro-well to an external hard drive attached to the USB port.
	Transfer Embryo Tag: Tap this icon to tag an embryo for transfer. Once tagged, the icon changes to  .
	Cryopreservation Tag: Tap this icon to tag an embryo for cryopreservation. Once tagged, the icon changes to  .
	Discard Tag: Tap this icon to tag an embryo for discarding. Once tagged, the icon changes to  .

Icon	Description
	Empty Micro-Well: Tap this icon to tag micro-wells with no embryos. Images from micro-wells tagged with this icon will not be exported. Once tagged, the icon changes to  .

7.9. Reviewing Active Patient Embryos

	<p>WARNING:</p> <p>During embryo development, time-critical checkpoints should be reviewed in real-time to allow for alternative assessment under microscopy, if the assessment using the recorded image is not clear.</p>
---	---



7.9.1. Time-Lapse Playback

Playback of the recorded images for active patients is accessed from the micro-well screen.



To access the micro-well screen:

1. Tap the desired chamber from the homescreen. The chamber screen is displayed.
2. To select, tap the micro-well to be viewed. The micro-well screen is displayed showing the last recorded image (see “7.8. Micro-Well Screen” on page 60).

To review the time-lapse images:

1. Slide the playback scroll bar button  to the desired starting point for playback. The scroll bar button can be used at any time during playback to quickly move between points of interest.
2. Tap the play icon  to start playback. Images are displayed at a rate of 10 images per second.

To pause playback: Tap the pause icon .

When the image is paused, tap the image rewind icon  or the image advance icon  to move one image back or forward.

To adjust the playback speed: Tap the playback speed icon . Geri can display an image taken every five, 10, 30 or 60 minutes.

7.9.2. Image Zoom

To increase the size of the image: Tap the zoom in icon .



The image can be repositioned by moving the image in the desired direction on the touchscreen.

To decrease the size of the image: Tap the zoom out icon .

7.9.3. Z-Stack (Focal Planes)

Geri can take up to 11 focal plane images.

To adjust the focal plane settings: see “4.5. Z-Stack Settings (Focal Plane)” on page 23.

To move between focal planes during embryo review: Tap  or . The z-stack scale (see below) shows the focal plane currently displayed.



7.9.4. Moving Between Micro-Wells

From the micro-well screen, the embryo in the next micro-well and the embryo in the previous micro-well can be quickly viewed.

To move to the next micro-well: Tap the display next micro-well icon . The embryo in the next micro-well is displayed at the same time point and with the same zoom and focal plane settings, as the micro-well previously displayed.

The micro-well (number and dot location) displayed on screen is also updated at the same time.



To move to the previous camera position: tap the display previous micro-well icon .

7.9.5. Check Storage Capacity



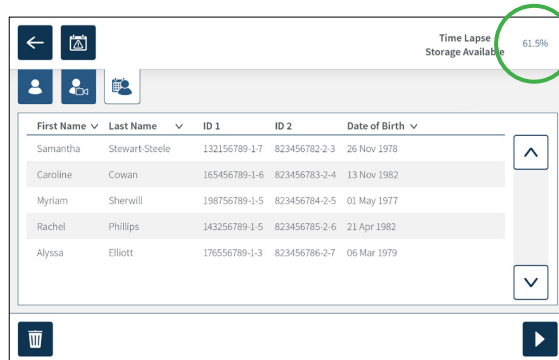





To check Geri's available storage: Tap the patient list icon . The percentage used will be displayed in the top right-hand corner of the screen.



7.10. Tagging Embryos

7.10.1. Tagging an Embryo from the Micro-Well Screen

From the micro-well screen, an embryo can be tagged using the following tagging icons:

Icon	Description
	Transfer Embryo Tag: Tap this icon to tag an embryo for transfer. Once tagged, the icon changes to  .
	Cryopreservation Tag: Tap this icon to tag an embryo for cryopreservation. Once tagged, the icon changes to  .
	Discard Tag: Tap this icon to tag an embryo for discarding. Once tagged, the icon changes to  .
	Empty Micro-Well Tag: Tap this icon to tag micro-wells with no embryos loaded. Images from micro-wells tagged with this icon will not be exported. Once tagged, the icon changes to  .

To tag an embryo:

1. Tap the desired tag icon. When selected, the tag icon changes to include the save icon.
2. Tap the save icon  to confirm and save the selection.

After the embryo in the micro-well has been tagged, the background of the icon changes from blue to white to indicate that it has been tagged.

7.10.2. Tagging Embryos from the Chamber Screen

From the chamber screen, multiple embryos in micro-wells can be tagged at the same time.

To tag multiple embryos:

1. Tap the multi-select icon .
2. Tap the desired embryos in micro-wells to be tagged.
3. Tap the desired tag icon.

After the embryos have been tagged, the display around the micro-well changes to reflect the new tag.

7.11. Reviewing & Exporting Data

The data generated by Geri can be reviewed at the Geri and then exported to an external drive connected to the USB port.

NOTE: Before exporting data, ensure that an external drive is connected to the USB port on the left side of the instrument.

The following data can be viewed on the Geri and exported from the Geri:

1. Individual patient reports
2. Time-lapse videos of individual embryos in one focal plane from actively recording and historical patients
3. Incubator parameters, including temperature, CO₂ and humidity
4. Alarm history

7.11.1. Exporting Patient Reports from the Chamber Screen

A patient report from an individual chamber can be exported from the chamber screen (see “7.6. Chamber Screen” on page 54).

To export individual patient reports:

1. Tap the desired chamber from the homescreen. The chamber screen is displayed.
2. Tap the export icon . The generate report pop-up window is displayed.

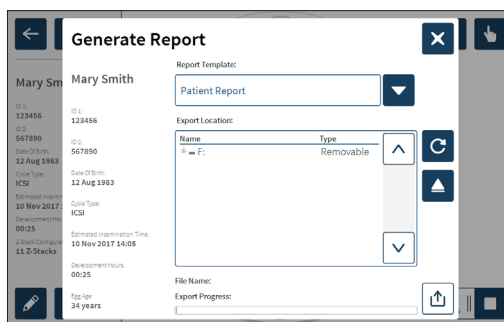

3. Tap the desired report template from the drop-down list to select.

4. Tap the desired removable drive from the export location field to select.
5. Tap the export icon  to confirm and export to the external USB hard drive.

To eject the external drive: see “7.12. Ejecting the External USB Drive” on page 69.

7.11.2. Exporting Time-Lapse Videos from the Micro-Well Screen

Videos from an individual micro-well can be exported from the micro-well screen (see “7.8. Micro-Well Screen” on page 60).

NOTE: the MP4 file is compatible with QuickTime® or VLC Media Player, but not Windows Media Player.

To export individual micro-well time-lapse videos:

1. Tap the desired chamber from the homescreen. The chamber screen is displayed.
2. Tap the desired micro-well from the chamber screen. The micro-well screen is displayed.
3. Select the desired focal plane to export.
4. Tap the export icon . The export video pop-up window is displayed.

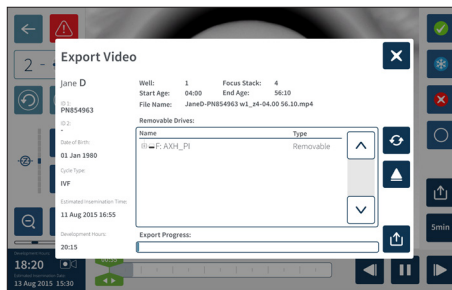



5. Tap the desired removable drive from the export location field to select.
6. Tap the export icon  to confirm and export to the external USB hard drive.

To eject the external drive: see “7.12. Ejecting the External USB Drive” on page 69.

7.11.3. Reviewing Embryos from Historical Patients

To review embryo images from an historical patient:

1. Tap the patient list icon  from the homescreen.
2. Tap the historical patients icon  to list all historical patients.
3. Tap the desired historical patient name to select.

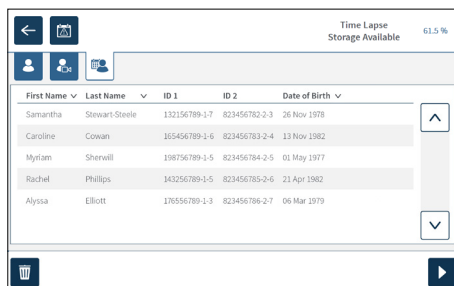





4. Tap the play icon  to show the chamber screen for the historical patient.
5. Tap the desired micro-well to review time-lapse images of an individual embryo.

7.11.4. Exporting Time-Lapse Videos from Historical Patients

NOTE: the MP4 file is compatible with QuickTime® or VLC Media Player, but not Windows Media Player.





To export embryo time-lapse videos from an historical patient:

1. Tap the patient list icon  from the homescreen.
2. Tap the historical patients icon  to list all historical patients.
3. Tap the desired historical patient name to select.
4. Tap the play icon  to display the chamber screen for the selected historical patient.
5. Tap the micro-well and select the desired focal plane to export.
6. Tap the export icon .
7. Tap the desired removable drive from the export location field to select.
8. Tap the export icon  to confirm and export images to the external USB drive.
9. Wait until the export progress is complete and then repeat the above steps to export any additional focal planes.

To eject the external drive: see “7.12. Ejecting the External USB Drive” on page 69.

7.11.5. Deleting Historical Patients

To delete an historical patient:

1. Tap the patient list icon  from the homescreen.
2. Tap the historical patients icon  to list all historical patients.
3. Tap the desired historical patient name to select.
4. Tap the delete icon  to delete the patient's images/videos.
5. Tap the confirm icon  to delete the selected patient.

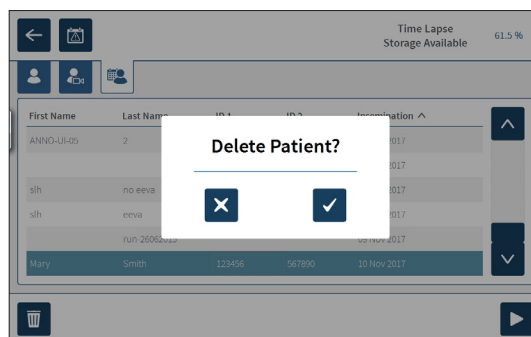

7.11.6. Reviewing Incubator Parameters

Geri records the incubator parameters of temperature and CO₂, as well as any humidification alarms and alarms triggered by chamber lids remaining open.

To view incubator parameters: Tap the settings icon  from the homescreen.

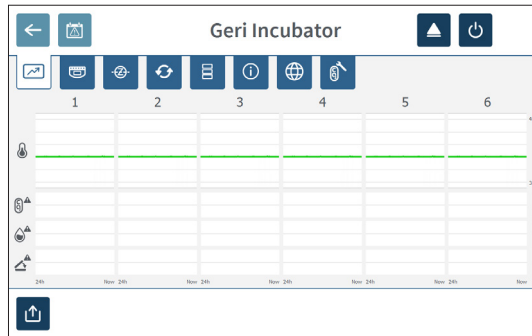

The basic incubator and software settings screen is displayed and defaults to the incubator parameters (graphics) tab. The parameters are displayed in graphical format, covering the previous 24 hours.



7.11.7. Exporting Incubator Parameters & Alarm History

Geri will export CSV files for each chamber – detailing temperature readings, CO₂ readings, humidity alarm and lid opening alarm – for the last 30 days.





To export incubator parameters:

1. Tap the settings icon  from the homescreen. The basic incubator and software settings screen is displayed and defaults to the incubator parameters tab.
2. Tap the export icon .
3. Tap the desired removable drive from the export location field to select.
4. Tap the export icon  to confirm and export the parameters to the external USB drive.

To eject the external drive: see “7.12. Ejecting the External USB Drive” on page 69.

7.11.8. Exporting Diagnostics Package



To export a diagnostics package:

1. Tap the settings icon  from the homescreen. The basic incubator and software settings screen is displayed and defaults to the incubator parameters tab.
2. Tap the information icon  to access the incubator information screen.
3. Tap the export diagnostics package icon . The export diagnostics screen is displayed.
4. Tap the desired removable drive from the export location field to select.
5. Tap the export icon  to confirm and export to the external USB drive.

To eject the external drive: see “7.12. Ejecting the External USB Drive” on page 69.

7.12. Ejecting the External USB Drive

To eject the external drive:

1. Tap the eject icon . The eject drive screen is displayed.
2. Tap the desired removable drive to select.
3. Tap the eject icon  to confirm.
4. Remove the drive from the USB port.

7.13. Powering Off







WARNING:

- Never power off the instrument while embryos are being cultured in any of the chambers.
- When powering off the instrument, remove the Geri water bottles from each chamber and allow the chamber to finish a purge cycle. Then power off the instrument according to the instructions below before leaving all the lids open to enable drying and cooling down of the inside of the chambers.

The Geri computer must be correctly shut down before the on/off switch at the rear of the instrument is switched off.

To shutdown the computer:

1. Tap the settings icon  from the homescreen.
2. Tap the shutdown icon . The shutdown confirmation pop-up window is displayed.
3. Tap the confirm icon  to confirm or the cancel icon  to cancel.

When the computer has shut down and the screen is blank, it is safe to switch Geri off using the on/off switch at the rear of the instrument.

7.14. Moving Geri to a Different Physical Location



WARNING:

To minimize the risk of injury:

- do not attempt to carry Geri alone; Geri weighs 40.35 kg
- Geri should only be carried by two people using the appropriate good-lifting and safe-carrying procedures.

Before moving, Geri should be powered off (see “7.13. Powering Off” on page 69).

7.14.1. Optics Transport Lock

Before Geri is moved to a different physical location, the optics transport lock should be engaged to minimize movement and avoid damage to the internal optics system.

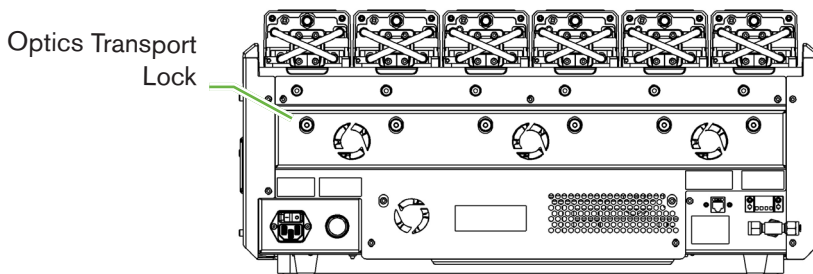

To engage the optics transport lock: use a size 4 Allen key to push the lock in and turn clockwise one quarter turn.

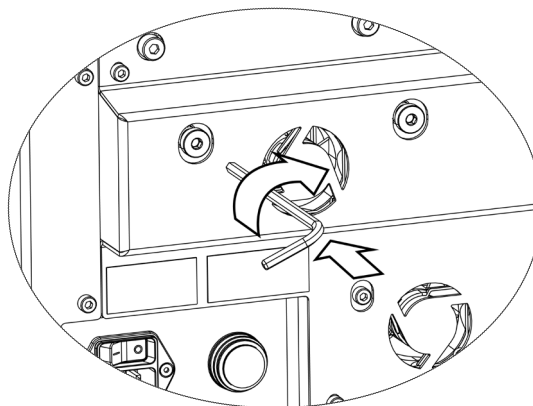

To disengage the optics transport lock: use a size 4 Allen key to turn counterclockwise one quarter turn.

8. ALARMS & WARNINGS

When an alarm or warning is activated, on the Homescreen the corresponding chamber will be highlighted red for an alarm (1), or yellow for a warning (2). When an alarm is activated, there is also an audible alarm.

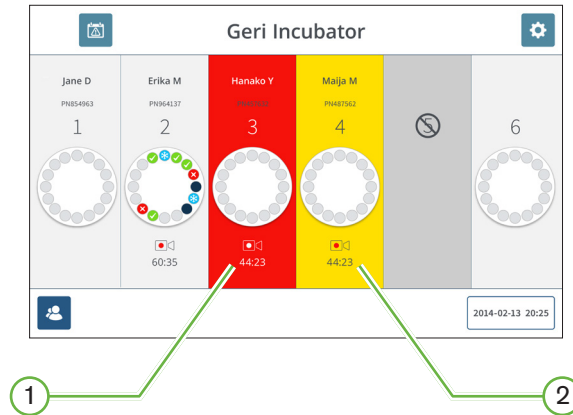

The corresponding chamber lid screen will also highlight the activated alarm or warning.

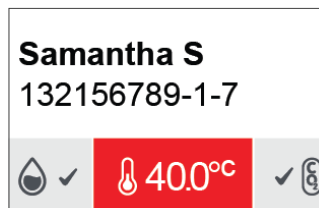

When an alarm is activated, the external alarm connection is also activated.





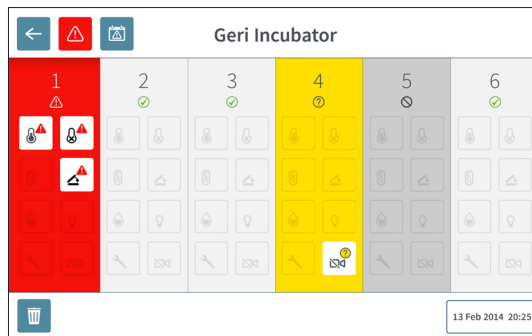



8.1. Alarms & Warnings Screen

The alarms and warnings screen provides additional information by displaying the current alarm and warning status of each chamber.



When an alarm or warning is activated, tap the alarm icon . The active alarm or warning is highlighted and the corresponding chamber will be highlighted red for an alarm or yellow for a warning. The specific alarm or warning is also highlighted.

The specific alarms and warnings are:

Icon	Description
	Temperature Alarm (see “Temperature Alarm” on page 74)
	Thermal Cut-Off Alarm (see “Thermal Cut-Off Alarm” on page 75)
	Gas Alarm (see “Gas Alarm” on page 75)
	Humidity Alarm (see “Humidity Alarm” on page 76)
	Lid Open Alarm (see “Lid Open Alarm” on page 77)
	Camera Illumination Alarm (see “Camera Illumination Alarm” on page 77)
	Service Alarm (see “Service Alarm” on page 77)
	Image Capture Offline Warning (see “Image Capture Offline Warning” on page 78)
	Incubation Controller Offline Warning (see “Incubation Controller Offline Warning” on page 78)

Tapping the highlighted alarm or warning icon displays additional information about that alarm or warning.

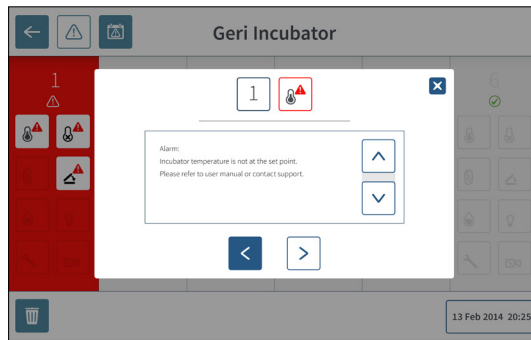

8.2. Alarms & Warnings History Screen

Geri records and maintains a history of all alarms and warnings.

To access the alarms and warnings history screen: Tap the alarms and warnings history icon  from the homescreen.

Alarm Source	Icon	Start Time	End Time	Description
Chamber 1		2018-01-04 10:10:31	2018-01-04 10:11:09	Incubator lid was open too long
Chamber 3		2018-01-04 10:10:12	2018-01-04 10:10:45	Thermal safety custom was activated
Chamber 6		2018-01-04 10:09:28	2018-01-04 10:10:37	Incubator temperature was not at the set point
Chamber 5		2018-01-04 10:09:36	2018-01-04 10:10:39	Instrument application startup
Chamber 2		2018-01-04 09:56:19	2018-01-04 10:10:04	Incubator lid was open too long
Chamber 3		2018-01-04 09:56:14	2018-01-04 10:11:26	Thermal safety custom was activated
Chamber 4		2018-01-04 09:56:07	2018-01-04 10:08:54	Incubator temperature was not at the set point
Chamber 6		2018-01-04 09:56:03	2018-01-04 10:09:15	Instrument application startup
Chamber 1		2018-01-04 09:55:57	2018-01-04 10:08:46	Instrument application startup
Chamber 2		2018-01-04 09:55:53	2018-01-04 10:08:50	Incubator lid was open too long
Chamber 4		2018-01-04 09:55:54	2018-01-04 09:59:25	Thermal safety custom was activated
Chamber 5		2017-12-03 03:56:07	2017-12-04 03:16:04	Incubator temperature was not at the set point
Chamber 3		2017-12-03 02:56:04	2017-12-04 02:56:08	Instrument application startup
Chamber 3		2017-12-03 22:26:09	2017-12-03 22:16:12	Alarm History has been reset
Chamber 1		2017-12-03 20:40:59	2017-12-03 20:41:10	Instrument application startup
Chamber 1		2017-12-03 02:12:12	2017-12-03 02:11:08	Alarm History has been reset

The alarms and warnings history screen displays a brief description of the alarm or warning, and where relevant, a start and end time for when the alarm or warning occurred.

8.3. Types of Alarms

8.3.1. Temperature Alarm

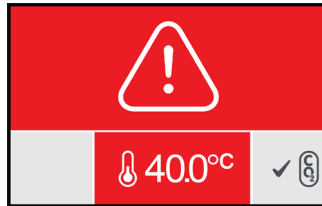

A temperature alarm is activated when the temperature within the chamber is beyond the temperature set-point by more than $\pm 0.4^{\circ}\text{C}$ (calculated over a two-minute period). The external alarm connection is also activated at the same time.

The temperature alarm will stop when the temperature within the chamber returns to within $\pm 0.35^{\circ}\text{C}$ (calculated over a two-minute period).

When the temperature alarm is activated, the audible alarm can be temporarily silenced by pressing the multi-function button located at the rear of the corresponding chamber.

NOTE:

- The alarm will continue to be displayed on both the main Geri homescreen and the chamber lid screen.
- The temperature alarm is temporarily disabled when Geri is powering on or if the temperature set-point for a chamber is changed. This enables time for the chambers to reach their temperature set-points.

8.3.2. Thermal Cut-Off Alarm

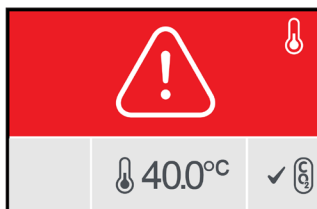

GerI has two incubation control systems that provide redundancy in maintaining the temperature set-point in the event of a component or firmware failure in one of the systems.

When a thermal cut-off alarm is activated, it indicates a component or firmware failure in one of the heating systems. The external alarm connection is also activated at the same time. Although the temperature within the chamber is maintained, the error is displayed so the thermal cut-off can be reset. The thermal cut-off alarm will stop when it has been reset.

To reset the thermal cut-off: GerI must be powered off and on again (see “7.13. Powering Off” on page 69).

When the thermal cut-off alarm is activated, the audible alarm can be temporarily silenced by pressing the multi-function button located at the rear of the corresponding chamber.

NOTE: The alarm will continue to be displayed on both the main GerI homescreen and the chamber lid screen.



WARNING:

Never power off the instrument while embryos are being cultured in any of the chambers.

8.3.3. Gas Alarm

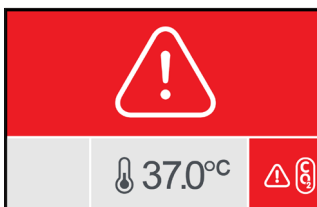

The gas alarm is activated when the CO₂ level within the chamber is beyond the specified CO₂ range set-points (calculated over a two-minute period). The external alarm connection is also activated at the same time.

The gas alarm will stop when the CO₂ level (calculated over a two-minute period) is inside the specified CO₂ range set-points.

When the gas alarm is activated, the audible alarm can be temporarily silenced by pressing the multi-function button located at the rear of the corresponding chamber.

NOTE:

- The alarm will continue to be displayed on both the main Geri homescreen and the chamber lid screen.
- When the chamber lid is opened, the CO₂ levels quickly drop below the CO₂ range set-points. When the chamber lid is closed Geri performs an automated chamber gas purge to return the CO₂ levels to within the CO₂ range set-points. The gas alarm is temporarily disabled during this process.

8.3.4. Humidity Alarm

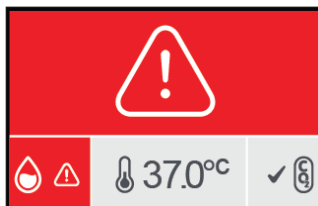

The humidity alarm is activated if the humidity level (calculated over a two-minute period) is below the specified low limit. The humidity alarm will trigger the local audible alarm and external alarm connection. In addition to the local audible alarm, a flashing alarm indicator will be displayed on the main Geri homescreen and the chamber lid screen.

The humidity alarm will stop when the humidity level (calculated over a two-minute period) is above the specified low limit.

NOTE:

- The humidity alarm is temporarily disabled while the incubator lid is open.
- The humidity alarm is temporarily disabled while the incubation chamber is purging.
- When the humidity alarm is triggered the user can temporarily silence the alarm for two minutes by pressing the multi-function button located at the rear of the corresponding chamber.
- The alarm will continue to be displayed on both the main Geri homescreen and the chamber lid screen.

The humidity alarm thresholds are listed in the following table. The alarm will be triggered if the relative humidity inside the chamber does not reach:

Relative Humidity Level	Time: Reference to end of Purge Cycle (Chamber Lid Closed)
15%	after two hours
60%	after four hours

8.3.5. Lid Open Alarm

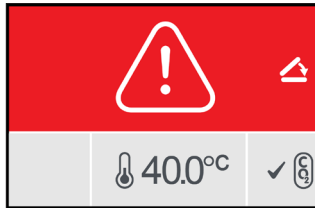

The chamber lid must be securely closed to ensure the correct operation of the chamber. A lid open alarm is activated when a chamber lid has not been correctly closed for over one minute. The lid open alarm will stop once the chamber lid is correctly closed (see “7.5. Accessing a Chamber” on page 51). If the lid has not been closed correctly, it is recommended to open and close the lid properly to enable the chamber purge.

8.3.6. Camera Illumination Alarm

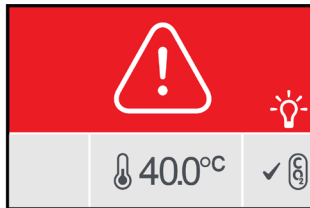

A camera illumination alarm is activated when the illumination LED has developed a fault and is not switching off. The camera illumination alarm will stop when the illumination LED is turned off. This may require the chamber to be turned off (see “4.4.4. Chamber On/Off Switch” on page 22).

When the camera illumination alarm is activated, the audible alarm can be temporarily silenced by pressing the multi-function button located at the rear of the corresponding chamber.

NOTE: The alarm will continue to be displayed on both the main Geri homescreen and the chamber lid screen.

8.3.7. Service Alarm



When a service alarm is activated, a significant failure of the chamber has occurred. The external alarm connection is also activated at the same time. Turn the chamber off (see “4.4.4. Chamber On/Off Switch” on page 22) and contact your local Genea Biomedx representative. The issue with the chamber will require servicing.

8.3.8. Loss of Power Alarm

Without power, Geri cannot maintain incubation temperature or CO₂ gas flow. A loss of power alarm is activated when Geri has been turned off (without the correct shutdown procedure) or has lost mains power.

To silence the audible alarm: use the loss of power silence button located next to the mains power socket at the rear of the instrument (see “2.4. Rear of the Instrument” on page 6).

If power has not been restored in approximately 100 seconds, the external alarm connection is activated. The delay in activating the external alarm allows for temporary loss of power that may occur in a UPS set-up.

The loss of power alarm will stop when Geri is turned back on or the mains power is restored.

When Geri is shut down correctly (see “7.13. Powering Off” on page 69), the loss of power alarm is disabled.

8.4. Types of Warnings

8.4.1. Image Capture Offline Warning



An image capture offline warning is activated when there is an issue with the camera mechanism. The issue may be a communications problem or faulty components within the camera mechanism.

During this time there is a risk that images will not be taken by the camera and as a result, alternative methods of reviewing the embryos should be considered.

8.4.2. Incubation Controller Offline Warning















An incubation controller offline warning is activated when there is an issue with communications between the chamber and the main computer.

During this time there is a risk that temperature and CO₂ levels may deviate from the set-points and as a result, consideration should be given to transferring embryos to a different chamber.

8.4.3. Other Warning Messages

Other non-critical warning messages are recorded and displayed in the alarms and warnings history screen (see “8.2. Alarms & Warnings History Screen” on page 73).

Icon	Warning Message	Suggested Action
	Configuration has been reset, please check settings.	Review incubator settings and adjust if required.
	Configuration has been recovered, please check settings.	Review incubator settings and adjust if required.
	Patient data has been cleared.	Re-add patient details to each chamber and re-start image capture.
	Patient data has been recovered, please check.	Check that the patient details in each chamber are correct.
	Instrument was powered up.	No action required.
	Image storage is almost full.	Consider exporting and clearing patient data.
	Alarm history has been reset.	No action required.
	Alarm history database failure, history not available.	No action required.
	Oldest alarm entries have been removed.	No action required.
	Encoding engine busy, interface performance may be degraded.	No action required.
	Instrument application start-up.	No action required.
	Time lapse storage is almost full.	Back-up and delete the oldest historical patient data.

9. SERVICE & MAINTENANCE

9.1. Changing the Filter

The filter in each chamber should be replaced every two months.

See “6. About the Accessories” on page 43 for information regarding the filter and “3.4.6. Gas Filter” on page 14 for directions on how to remove and insert a filter.

9.2. Changing the Geri Water Bottle

The expected time for a full Geri water bottle (from maximum fill level) to reach the minimum fill level is two (2) weeks.

See “5.2. Geri Water Bottle” on page 40 for information regarding the Geri water bottle, and “7.5.2. Placing & Removing a Geri Water Bottle” on page 53 for directions on how to place and remove a Geri water bottle.

9.3. Routine Cleaning

Decontamination of instrument surfaces is recommended as part of routine use and maintenance, but should also be carried out immediately after media spills or when other contamination is visible. Effective decontamination comprises cleaning to remove visible soil and disinfection, to provide a surface free from all forms of microbial life (except for large numbers of bacterial spores). The procedures described below are recommended when there is visual evidence of contamination/soiling and have been validated to demonstrate their effectiveness.

9.3.1. Cleaning of the Geri Incubator

1. Cleaning should be performed on an empty instrument (no embryos in place and access door open). Ensure that there is adequate lighting to visualize areas of contamination.
2. Remove visible contamination with a low shedding absorbent wipe moistened with high purity water.
3. Moisten another low shedding absorbent wipe with high purity water and wipe all accessible surfaces of the instrument.
4. Repeat the wiping steps at least three times or until no residue is visible on the wipe. Use a new wipe for each wiping step.
5. If the instrument is determined to not be visually clean (including under magnification, if necessary), repeat steps 2 and 3 until the instrument is visually clean.
6. Moisten a low shedding absorbent wipe with 70% isopropyl alcohol and wipe all accessible surfaces of the device.
7. Leave the access door open and allow 1 hour for moisture to dissipate and to appear visually dry.
8. Proceed to disinfection.

9.3.2. Disinfection of the Geri Incubator

1. Disinfection should be performed on an empty instrument (no embryos in place and access door open).
2. Moisten a low shedding absorbent wipe with 70% isopropyl alcohol and wipe all accessible surfaces of the instrument.
3. Repeat step 2 at least three more times. Use a new wipe for each wiping step.
4. Leave the access door open and allow 1 hour for alcohol fumes to dissipate and to appear visually dry.

9.4. Annual Maintenance

In order to ensure optimal Geri performance, an annual inspection is necessary for early detection of possible malfunctions.

Annual maintenance is to be carried out by an authorized service technician.

9.5. Decontamination

Should it be determined that the instrument is to be returned to Genea Biomedx for servicing, the instrument will require decontamination.

Decontamination must be carried out by an authorized service technician or a Genea Biomedx representative.

9.6. Backing Up and Removing Data

Depending on the level of usage of Geri, data should be backed up to an external USB drive and deleted from the hard drive of Geri every month, sooner if required.

See “7.11.2. Exporting Time-Lapse Videos from the Micro-Well Screen” on page 66 and “7.11.4. Exporting Time-Lapse Videos from Historical Patients” on page 67 for information on exporting data to an external USB drive. See “7.11.5. Deleting Historical Patients” on page 67 for information on deleting data from Geri.

10. TECHNICAL SPECIFICATIONS

10.1. Instrument Specifications

Classification according to IEC 61010-1

Type of protection against electric shock	Electrical safety 61010-1
Degree of protection against harmful ingress of solids and water	IP2X

General Specifications

Power supply	100–240 VAC
Frequency	50/60 Hz
Maximum power consumption	1200 VA
Electrical rating	100–240 V ~ 50/60 Hz 3.2–1.5 A
Alarm contact rating	1 A 30 V DC
Environmental operating conditions	+18°C to +30°C
Storage and transport directions	Store in a cool dry place
Designed and verified to the following standards	Electrical safety 61010-1 Electromagnetic compatibility 61326-1 Software development ISO 62304
Dimensions	Lid closed: 615 mm wide x 300 mm high x 500 mm deep Lid opened: 615 mm wide x 500 mm high x 500 mm deep
Weight	40.35 kg
Gas supply type	Blend of 6% CO ₂ , 5% O ₂ , 89% N ₂ (at sea level) or high purity 6% CO ₂ in air (recommended tolerances ±0.2%)
Gas supply pressure	150 kPa ± 15 kPa (21.8 psi ± 2.2 psi) (1500 mbar ± 150 mbar)
Gas flow rate capability	Minimum 1080 mL/min per Geri instrument
Gas flow rate accuracy	±15% of flow per chamber
Chamber temperature capability	+35°C to +40°C in 0.1°C increments in ambient temperature range of +20°C to +28°C. At set-point of +37°C, the ambient temperature range is extended to +18°C to +30°C.
Chamber temperature accuracy	±0.2°C at calibration point
Filter	HEPA filter retains 99.97% particles > 0.3 µm
Recovery time of temperature after lid opening/closing	< 1 minute
Recovery time of CO ₂ after lid opening/closing	< 3 minutes
Recovery time of humidity after lid opening/closing	4 hours

Camera Specifications

Camera	2560 x 1928 pixels monochrome CMOS camera
Resolution	2 pixels per μm
Illumination (Geri)	Single orange LED (591 nm, duration < 0.005 seconds per image)
Total exposure time (Geri)	Total light exposure \sim 162 seconds per day per embryo

10.2. Consumable Specifications**10.2.1. Geri Dish Specifications**

Material	Crystalline polystyrene
Capacity	16 micro-wells
Micro-well dimensions	Base diameter: 430 μm Top diameter: 500 μm Depth: 400 μm

10.2.2. Geri Water Bottle Specifications

Material	Crystalline polystyrene
Capacity	i. Volume to max line: 15.5 mL ii. Volume from min to max line: 11.5 mL

10.3. Accessory Specifications**10.3.1. Filter Specifications**

Housing	Polypropylene
Membrane	PP-reinforced PTFE
Pore size	0.20 μm
Connectors	Luer lock inlet and Luer slip outlet

10.4. Chamber Sensor Specifications

Chamber temperature sensor capability	Each temperature sensor in the Geri chamber is capable of sensing +35°C to +42°C with accuracy within 0.2°C.
Temperature sensors per chamber	There are four temperature sensors built into each Geri chamber (two in the chamber lid and two in the chamber base).
Chamber humidity sensor capability	Each chamber is fitted with a humidity sensor capable of sensing 0 to 100% RH with an accuracy of \pm 6% RH.

Recovery time of temperature after lid opening/closing

Multiple heating elements ensure temperature stability. The chamber is returned to the temperature set-point in **less than one minute**. Should one of the heating elements fail, the remaining heating elements are able to maintain the chamber temperature.

Monitoring chamber temperature with an external probe

Temperature can be measured with an external probe through the temperature external monitoring port (see the rear view of instrument image below).

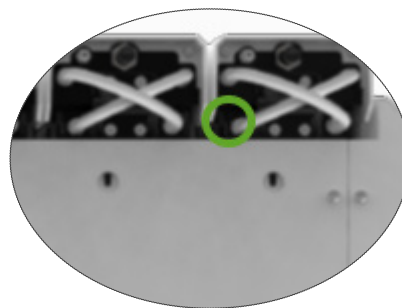

There are various Remote PT100 sensors (PT100 Class A to EN60751) available.

To fit the monitoring ports the sensor must meet the following specifications:

- Maximum diameter 2.51 mm
- Minimum length 100 mm
- Sensing region should be within 15 mm of the tip.

See www.omega.co.uk/pptst/PR-16.html for one option.

Chamber CO₂ sensor capability

Geri's CO₂ is monitored by an NDIR (non-dispersive infra-red) sensor and has a range of 0 to 20%. The sensor's accuracy is $\pm 5\%$ **of the reading**, but the overall accuracy is dependent on numerous factors, such as atmospheric pressure that can change the CO₂ concentration in the gas.

CO₂ sensors per chamber

There is one CO₂ sensor built into each Geri chamber.

Gas purge after lid opening/closing

Every time the chamber is opened and closed, a gas purge is activated to accelerate the process of re-establishing optimum gas levels in the chamber. Optimum levels should be reached in **less than three minutes**.

Monitoring chamber CO₂ with an external probe

CO₂ can be measured through the gas external monitoring port (see the rear view of instrument image below).

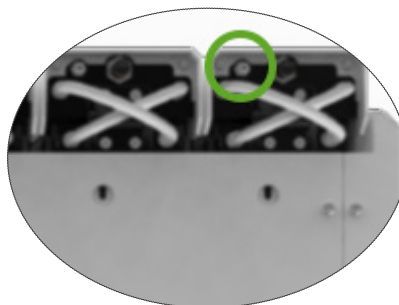

Chamber camera capability

Each chamber has a five megapixel camera to provide detailed time-lapse views of each embryo at a resolution of two pixels per μm .

Images of up to 11 focal planes of each embryo are taken every five minutes.

The camera light source is amber and within the range of wavelength safe for embryos at 550nm to 650nm.

Cameras per chamber

One

Recording during lid opening/closing

There are no sensors to communicate when a Geri dish has been added or removed from the chamber. Images will continue to be recorded during a patient's session even if the Geri dish is removed (for example, for media change). Since the Geri dish is rarely kept out of the chamber for more than 5–10 minutes, the time-lapse playback would show 1–2 blank frames.

NOTE: It is important to only press the Stop Record icon at the completion of a patient's recording session, not when temporarily removing a Geri dish for media change.

10.5. Life of the Instrument

The life of the instrument is deemed to be five years. Genea Biomedx accepts no responsibility for this product after this time period.

11. INDEX

A

Accessories

- filter, 43
 - directions for use, 14
 - installing, 14
 - removing, 14
 - replacing, 80
 - specifications, 83
 - storage, 41

Alarms & Warnings

- alarm connection, See External Alarm Connection
- alarms & warnings history screen, 73
- alarms & warnings screen, 72
- camera illumination alarm, 77
- gas alarm, 75
- humidity alarm, 76
- image capture offline warning, 78
- incubation controller offline warning, 78
- lid open alarm, 77
- loss of power alarm, 78
- loss of power alarm silence button, 7
- service alarm, 77
- temperature alarm, 74
- thermal cut-off alarm, 75
- warning messages, 79

Assess 2.0, See **Geri Assess 2.0**

B

Basic Image Settings, 32

- camera alignment, adjusting, 34
- camera focus, adjusting, 33
- image contrast, adjusting, 33

C

Camera Alignment, See **Basic Image Settings**

Camera Focus, See **Basic Image Settings**

Chamber

- accessing, 51
- chamber lid screen, 47

- chamber screen, 54
- chamber sensor specifications, 83
- icons, 55
- on/off switch, 22
- patient allocation, 50

Charcoal Filters

- using an external charcoal filter, 14

CO₂ Range Set Point

- changing set points, 20

CO₂ Reference Point, 29

- calibrating, 29
- maintenance, 31

Consumables

- about, 36
- Geri dish,
 - about, 37
 - directions for use, 39
 - loading into a chamber, 52
 - loading embryos, 40
 - removing from a chamber, 52
 - removing embryos, 40
 - storage, 39
- Geri water bottle
 - changing the bottle, 80
 - directions for use, 41
 - placing in a chamber, 53
 - removing, 53
 - storage, 41
 - specifications, 83

Contact, See **Manufacturer**

Cycle Type

- adding a new cycle type, 24
- assigning cycle type, 57
- default cycle types, 24
- editing a cycle type, 25
- parameters, 24

D

Date & Time, 26

Dish, See **Consumables - Geri dish**

Drive, external, See **USB drive**

- E**
- Electrical Safety, 1**
 - Electromagnetic Compatibility, 2**
 - Embryos**
 - reviewing historical patients, 66
 - tagging embryos
 - from the chamber screen, 65
 - from the micro-well screen, 66
 - Exporting Data**
 - diagnostics package, 68
 - incubator parameters, 68
 - incubator parameters alarm history, 68
 - patient reports, 65
 - Exporting Images**
 - from historical patients, 67
 - from the micro-dish well screen, 66
 - External Alarm Connection, page 7, 15**
 - External Temperature Monitoring, page 7**
- F**
- Filter, See Accessories; filter; See also Char-coal Filters**
- G**
- Gas**
 - connecting to multiple instruments, 13
 - connection location, page 7
 - connection to gas cylinder, 12
 - cylinder regulator recommendations, 11
 - external monitoring, page 6
 - filter, See Accessories; filter,
 - mixture required, 11
 - other connections, 14
 - supply, 11
 - Geri**
 - consumables, See Consumables
 - description, 3
 - front of the instrument, 5
 - handling & placement, 10
 - homescreen, 45
 - included items, 10
 - intended use, 3
 - life, 85
 - moving location, 70
 - operation, 44
 - parameters, 18
 - powering off, 69
 - preparation for use, 44
 - rear of the instrument, 6
 - service & maintenance, 80
 - sides of the instrument, 8
 - software settings, 16
 - technical specifications, 82, 83
 - touchscreen, page 5
- Geri Assess 2.0**
- adding a patient, 48
 - adding a patient to Geri Connect, 49
- H**
- Hazardous Material, 1**
 - Help, See Technical Support**
 - Humidity Alarm, 76**
 - switching on/off, 21
- I**
- Icons, See also Symbols**
 - alarms & warnings, 72
 - basic image settings, 32
 - chamber screen, 55
 - embryo tags, 64
 - homescreen, 46
 - incubator & software settings, 17
 - micro-well screen, 61
 - warning messages, 79
 - Image Contrast, See Basic Image Settings**
 - Images, See Z-Stack; See Basic Image Settings; See Playback; See Recording Images**
 - Incubator Parameters**
 - accessing, 18
 - Incubator Parameters (Graphic Format)**

- accessing, 18
- exporting, 68
- reviewing, 68

Insemination

- adjusting date or time, 56
- estimation, time, 56

Installation

- installation & maintenance, 2
- installation & set-up, 10
- installation & set-up checklist, 35

Instrument Parameters, 24

L

Language, changing, See Localization

Localization, 27

M

Mains Power Socket, See Power Socket

Manufacturer, 3

Micro-Well

- moving between micro-wells, 63

Micro-Well Screen, 60

Moving Geri, See Geri; Moving Location

Multi-Function Button, page 6

O

Optics Transport Lock, 70

P

Patient

- adding patient details, 48
- allocating to a chamber, 50
- editing patient details, 49
- exporting patient reports, 65
- reviewing embryos, 62
- reviewing historical patient embryos, 66

Playback

- image playback, 62
- image zoom, 62
- reviewing images, 62

Powering Off, 69

Powering On, 16

PC Power Button, page 8

Power Socket, page 7

R

Recording Images

- embryo development, 56
- start recording, 57
- stop recording, 59

S

Safety Instructions, 1

Sensor, CO₂, See Calibration

Service & Maintenance

- annual maintenance, 81
- cleaning, 80
- decontamination, 81

Software Settings, 16

Switching on the Instrument, See Powering On

Symbols, See also Icons
package labeling, XII, 36

T

Technical Specifications, 82, 83

Technical Support, 3

Temperature Monitoring, See External Temperature Monitoring

Temperature Set-Point
adjusting the set-point, 19

Time, Adjusting, See Date & Time

Time-Lapse Images, See Playback; See Basic Image Settings; See Recording Images; See Z-Stack

Touchscreen, See Geri; touchscreen

Transporting Geri, See Geri; Moving location

U

USB Drive
ejecting, 69

preparing Geri for use, 44
USB port, page 8

W

Warnings & Cautions, VII

Z

Z-Stack

settings (focal plane), 23

